

MODERNE TECHNOLOGIE EN
UITSTEKENDE PRESTATIES VOOR
MAXIMALE KOSTENEFFICIENTIE

It all starts with  **VARTA®**



NU IS HET NOG EENVOUDIGER OM PRECIES TE VINDEN WAT U NODIG HEBT

Deze catalogus is uw essentiële gids voor ons assortiment geavanceerde batterijen voor zware bedrijfswagens. Hier vindt u alle feiten en cijfers over onze technologieën en producten en hoe u de Total Cost of Ownership (TCO) kunt verlagen.

Hoe en waar u de passende VARTA® batterij vindt

Voer op onze homepage www.varta-automotive.com voertuigproducent en -model of geselecteerde kenmerken in en de online productenvinder vindt snel wat u nodig hebt.

Als u de naam van het product hebt gevonden, geef dan uw land en postcode in en onze dealerzoeker stelt voor u een lijst samen met dealers in uw omgeving.

U kunt ook gebruik maken van de lijst met toepassingen op pagina 19 van deze catalogus.

www.varta-automotive.com

Bereken met onze online besparingscalculator hoeveel u kunt besparen op de Total Cost of Ownership

Duurzaam geconstrueerd. Ontworpen om de Total Cost of Ownership te verlagen

Al onze batterijen zijn onderhoudsvrij en dat zorgt voor besparingen bij de service. Bovendien spaart u bij stilstandtijden, brandstof en aanschaf. Met onze online besparingscalculator ziet u precies hoeveel u voor uw wagenpark bespaart als u overstapt van conventionele batterijen.

Om de besparingscalculator te testen gaat u naar: www.varta-automotive.com





INHOUD

- 4** / OVER VARTA®
- 6** / VERLAGEN VAN DE TOTAL COST OF OWNERSHIP
- 8** / PROMOTIVE SILVER, PROMOTIVE BLUE,
PROMOTIVE BLACK
- 10** / DE INNOVATIE VAN BINNEN
- 12** / TOEPASSINGEN
- 14** / ECOSTEPS®
- 15** / SPECIFICATIES
- 17** / OVER DEZE CATALOGUS
- 19** / LIJST MET TOEPASSINGEN



WAAROM U KUNT VERTROUWEN OP VARTA® BATTERIJEN – EN ONS GERUST KUNT AANBEVELEN AAN UW KLANTEN

De afgelopen eeuw kende een zeer snelle ontwikkeling van de voertuigtechnologie en VARTA was steeds een stuwende kracht achter de ontwikkeling van eersteklas batterijtechnologieën en innovatieve service. Zo konden wij wereldwijd een uitstekende naam opbouwen, zowel bij de eerste montage (OEM) als ook in de aftersalesmarkt.

Tegenwoordig vindt u onze producten in miljoenen auto's, speedboten, motorfietsen, campers...

Tallose mensen en bedrijven vertrouwen dus dagelijks op VARTA. En dat kunt u ook, als u kiest voor één van onze producten.

VARTA producten zijn gemaakt voor een hoog vermogen en grote betrouwbaarheid, minder corrosie en meer efficiëntie voor een langere levensduur, met als resultaat lagere bedrijfskosten.

In ons brede assortiment vindt u:

- Voor lichte en zware bedrijfswagens combineert ons **Promotive Trio assortiment** een lange levensduur en absolute betrouwbaarheid met lage Total Cost of Ownership
- Voor standaard toepassingen in voertuigen biedt het **Dynamic Trio gamma** onze gepatenteerde **PowerFrame®** technologie met exact gestanste roosters
- Voor voertuigen met Start-Stop zorgt ons **Start-Stop assortiment** met de moderne AGM-technologie voor meer brandstofefficiëntie en een extreem betrouwbare oplaadcyclus
- Voor motorfietsen, jetski's, quads en sneeuwscooters biedt het **Powersports assortiment** veel toepassingsmogelijkheden
- Voor boten en caravans staat het **Professional assortiment** ter beschikking dat een indrukwekkende betrouwbaarheid, een ideale prijs-prestatieverhouding en uitstekende ontladcycli biedt



Veel voertuigproducenten vertrouwen op VARTA®. En dankzij onze uitgebreide ervaring, innovatie, prestatie, dienstverlening en ondersteuning, waar u altijd op kunt rekenen, kunnen u en uw klanten dat ook.

It all starts with VARTA®



VERTROUW OP VARTA® BATTERIJEN ALS KRACHTBRON VOOR UW WAGENPARK EN OM GELD TE BESPAREN

De keuze van de juiste batterij speelt een belangrijke rol in het professionele wagenparkmanagement. Ze zijn ten slotte van cruciaal belang om uw voertuigen de energie te bieden die ze nodig hebben om ook onder zware omstandigheden te starten.

De batterij moet bovendien een breed en complex assortiment boordsystemen, toepassingen en uitrustingen van energie voorzien. En omdat tijd geld is, moet het een uiterst betrouwbaar product zijn.

Omdat elke onderneming en organisatie op haar geld moet letten, lijken goedkope producten weliswaar verleidelijk, maar op termijn zorgen ze zelden voor lagere kosten.

Daarbij worden vaak de kosten vergeten die stilstand en onderhoud van conventionele startbatterijen veroorzaken en die bovendien flink kunnen oplopen. Onderhoudsvrije VARTA producten zorgen er echter voor dat stilstand tot het verleden behoort. Ze betalen zichzelf dus terug.

Bereken precies hoe een VARTA Promotive batterij zichzelf terugbetaalt

Op termijn loont kwaliteit altijd. Hier vindt u een voorbeeld van een wagenpark van 60 voertuigen dat van conventionele batterijen overstapt op onderhoudsvrije VARTA Promotive batterijen. Zoals u ziet, heeft de vervanging een positief effect.

Beginwaarden*

Service-intervallen	2 keer per jaar	Loonkosten per uur voor monteur	100,00 €
Tijd voor batterijservice	circa 17,5 min.	Service tijdens levensduur batterij	circa 3 jaar

Kostenefficiëntie – onderhoudskosten voor conventionele batterijen

Kosten per servicebeurt	Loonkosten per uur x effectieve tijd voor 2 batterijen	58,33 €
Jaarlijkse onderhoudskosten	€ 58,33 x 2 servicebeurten per voertuig	116,67 €
Onderhoudskosten voor 3 jaar	€ 116,67 x servicebeurten in 3 jaar	350,00 €
Onderhoudskosten voor wagenpark	€ 350,00 x 60 voertuigen	21.000,00 €
Jaarlijkse kosten voor wagenpark		7.000,00 €

VARTA Promotive Trio onderhoudskosten

Jaarlijkse onderhoudskosten voor een wagenpark		0,00 € 
--	--	---

* Geschatte gemiddelde waarde

Om te zien hoeveel u in uw wagenpark kunt besparen, kunt u onze besparingscalculator proberen op www.varta-automotive.com

KWALITEIT LOONT OP TERMIJN

De batterij is het hart van het elektronische systeem. Daarom is het uiterst belangrijk om het juiste product in te bouwen. Uitrusting, aantal stops en chauffeursgedrag (bijv. snel of gematigd optrekken) hebben invloed op het benodigde energieniveau. Kies voor een VARTA® Promotive batterij en u verlaagt stilstandtijden en verhoogt besparingen.



VARTA batterijen zijn speciaal gemaakt voor de stroomvoorziening van een groot aantal technische apparaten en een lange lijst met voertuigtechnologieën en -uitrustingen. Hier vindt u een kleine selectie voor trucks en bussen.

Trucks

- Veiligheidsuitrusting (bijv. afstandsregeling, spoorassistent...)
- Comfort (bijv. airco, koelkast, koffiezetapparaat...)
- Digitale tachometer, telematicasysteem
- Boordcomputer, laptop, TV
- Trailer (koelsysteem, hydraulische laadklep...)
- Verlichting (binnen & buiten)

Bussen

- Veiligheidsuitrusting (bijv. afstandsregeling, spoorassistent...)
- Comfort (bijv. airco, koelkast, koffiezetapparaat, wifi...)
- GPS-alignment (bijv. afstand tot de volgende halte)
- Radiodatatransmissie (RDT voor verkeerslichten)
- Passagiersinformatiesystemen (LCD-displays, TFT-displays...)
- Kaartjesautomaat, verlichting (binnen & buiten)

GEBOUWD OM UW WAGENPARK OPTIMAAL TE LATEN RIJDEN

VARTA® Promotive batterijen zijn speciaal gemaakt om uw hele wagenpark van energie te voorzien en de bedrijfskosten te verlagen. Of het nu gaat om trucks, vans, touringcars, brandweerwagens, maaimachines of bouwvoertuigen, met ons ongeëvenaarde assortiment doet u uw werk met minder stilstandtijden en duidelijk lagere kosten.

Promotive Silver

Geniet elke dag van topprestaties en vermijd dure stilstandtijden. Promotive Silver is de perfecte keuze voor bedrijfswagens met een uitgebreide uitrusting zoals trucks, bussen en brandweerwagens. Dit geavanceerde, onderhoudsvrije product biedt een hoge cyclusvastheid en een lange levensduur dankzij onze Super Heavy Duty (SHD) technologie. Het resultaat? Significante besparingen voor uw bedrijf.

- Speciaal gemaakt voor hoogwaardige bedrijfswagens die een hoog vermogen en trilbestendigheid vereisen
- De nieuwste Original Equipment (OE) technologie en het laagste waterverbruik voor de hoogste besparingen in uw bedrijfskosten
- Overtreft de EN Super Heavy Duty (SHD) vereisten (EN-4-standaard en trilbestendigheid V3)



Promotive Blue

Hebt u een uitstekende allrounder nodig? Dit veelzijdige product is gemaakt voor de breedste en meest veeleisende inzet, inclusief alle voertuigen voor landbouw en gebruik bij de overheid, bestelwagens en distributievoertuigen. En omdat Promotive Blue het beste koudstartvermogen voor grote motoren biedt, kunt u vanaf het eerste moment vertrouwen op vermogen en betrouwbaarheid.

- Speciaal gemaakt voor hoogwaardige bedrijfswagens met een normale energiebehoefte
- Uitgebreide Original Equipment (OE) technologie en het laagste waterverbruik voor de hoogste besparingen in uw bedrijfskosten
- Voldoet aan de EN-eisen (EN 3) standaard en trilbestendigheid (V2)



Promotive Black

Oudere voertuigen en voertuigen met een lage energiebehoefte, inclusief bulldozers, minibussen en kleine tractoren hoeven een solide en betrouwbare prestatie niet te missen. Dankzij de beproefde hybridetechnologie stelt Promotive Black een uitstekende vermogensreserve ter beschikking. Onder normale werkomstandigheden is ze het gehele jaar onderhoudsvrij en dat voor lagere kosten.

- Ideaal voor voertuigen met een lagere energiebehoefte
- Standaard Original Equipment (OE) technologie en het laagste waterverbruik voor de hoogste besparingen in uw bedrijfskosten
- Voldoet aan de EN-eisen (EN 2) standaard en trilbestendigheid (V1)





Uitrusting	<i>Promotive Silver</i>	<i>Promotive Blue</i>	<i>Promotive Black</i>
Nr. van batterijtype	3	5	36
Besparingspotentieel bij de Total Cost of Ownership (TCO)*	Best	Better	Good
Technologie	Labyrintdeksel	Labyrintdeksel	Gebruikelijk deksel
Roostertechnologie	PowerFrame®	PowerFrame®	PowerFrame®
Trilbestendigheid	Long Life Super Heavy Duty (EN4 V3 standaard)	Long Life Heavy Duty (EN3 V2 standaard)	Long Life (EN2 V1 standaard)
OE-kwaliteit	Voldoet aan OE-eisen	Voldoet aan OE-eisen	Voldoet aan OE-eisen
Zelfontlading* (opslaglevensduur)	18 maanden	15 maanden	12 maanden
WATERVERBRUIK	Extreem laag	Zeer laag	Laag

*In vergelijking met conventionele onderhoudsvrije batterijen

INNOVATIE DIE UW BEDRIJFSKOSTEN VERLAAGT

Geen andere batterij is zo geconstrueerd als een product van VARTA®. Onze technologie met labyrintdeksel, calcium-zilver en Acid Reserve design is duidelijk veiliger en sterker dan conventionele constructies.

Labyrintdekseltechnologie

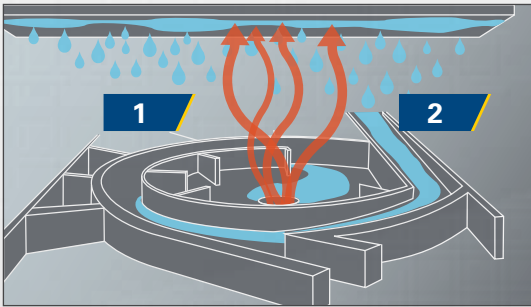

Veilig bij kantelen

Het unieke labyrintdekseldesign in elke Promotive Silver en Promotive Blue batterij zorgt voor 100% kantelveiligheid, zelfs bij een kanteling tot 90°. En zo werkt het:

- 1 Waterdamp condenseert aan het batterijdeksel
- 2 Water vloeit dankzij het design van het labyrintdeksel veilig terug in de batterij

Intelligent en veilig design

Centrale ontgassing

De in het labyrintdeksel geïntegreerde centrale ontgassing zorgt voor een veilige afvoer van ontstane gassen, terwijl de geïntegreerde vlamdovers de batterij beschermen tegen vonken en vlammen.

- 1 Geïntegreerde vlamdovers
- 2 Centrale ontgassing



Veiligheidsstop

De stevige veiligheidsstoppen werken als een golfbreker in het binnenste van de batterij en garanderen ook bij sterke schokken een maximale lekbestendigheid.

- 1 Extra dichtingsring ondersteunt kantelveiligheid





PowerFrame®-roostertechnologie

De unieke roosterstructuur biedt een perfecte energiedoorstroming en garandeert lage weerstand en optimale conductiviteit. Dat betekent dat elke VARTA® batterij gegarandeerd snel oplaadt, een extreem hoog startvermogen heeft en buitengewoon corrosiebestendig is. Kortom: ze is gemaakt voor buitengewone prestaties tijdens haar lange levensduur.

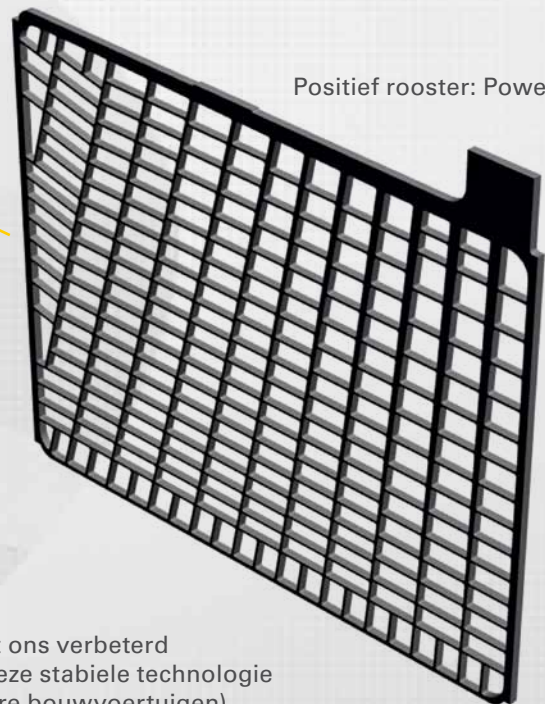

Positief rooster: PowerFrame

Super Heavy Duty (SHD) technologie

De SHD technologie in elke Promotive Silver batterij combineert ons verbeterd roosterdesign met een envelopseparator met microglasvezel. Deze stabiele technologie is ideaal voor zware bedrijfswagens (bijv. trucks, bussen en zware bouwvoertuigen).

De glasvezel garandeert enerzijds een driemaal hogere cyclusvastheid en een tienmaal hogere trilbestendigheid ten opzichte van conventionele batterijen. Anderzijds waarborgt het unieke design dat de elektrolyt voortdurend in contact blijft met de roosterstructuur. Daardoor kunt u ook bij extreem koude startomstandigheden altijd vertrouwen op de hoogste startenergie.

Acid Reserve Design

Doordat het interieur van de batterij maximaal wordt benut, is er geen ruimte meer voor bezinksel onder de elektroden. Dankzij de grotere vrije ruimte voor het zuur-watermengsel boven de elektroden wordt het corrosiegevaar voor open loodconnectoren tot een minimum gereduceerd. Bovendien zorgt de constructie voor maximale veiligheid, omdat er geen water hoeft te worden bijgevuld; dat zorgt ervoor dat de batterij langer een hoog vermogen biedt.

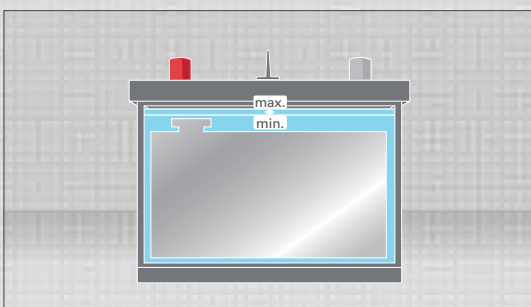

Conventionele batterij met een traditionele constructie

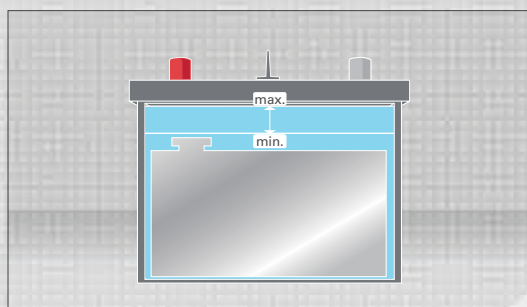

Nieuw design met lager geplaatste platen voor een grotere vloeistofinhoud



VOOR ELKE TOEPASSING VERLAGEN WIJ UW TOTALE KOSTEN

Of het nu gaat om trucks, vans, touringcars, brandweerwagens, maaidorsers of bouwvoertuigen; VARTA® Promotive is speciaal gemaakt om uw complete wagenpark zware bedrijfswagens van maximale energie te voorzien.

Dankzij deze betrouwbaarheid verlaagt u de kosten voor stilstand drastisch, want onze VARTA Promotive batterijen gaan langer mee, zijn sterker, hebben geen onderhoud nodig en helpen u voortdurend om geld te sparen.

Trucks

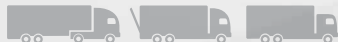

VARTA Promotive batterijen zorgen er zelfs bij slecht weer voor dat uw voertuigen startklaar zijn. Omdat ze absoluut onderhoudsvrij zijn, kunt u uw voertuigen langer inzetten. En met de hogere cyclusvastheid, die het ongelijkmatige op- en ontladen bij een lange inzet met veel stops tegengaat, zijn onze batterijen perfect om kosten te verlagen.

VARTA Promotive biedt:

- Gemak – een buitengewoon vermogen waarmee de nieuwste elektronische apparaten in de truck worden voorzien van energie
- Maximaal startvermogen – zelfs na lange stilstand bij de laagste temperaturen
- Geen onderhoud – doordat u geen tijd verliest met onderhoud, zijn uw voertuigen langer onderweg en spaart u meer kosten

Distributievervoer



Distributievoertuigen hebben batterijen nodig die voor het laden en lossen maximale energie ter beschikking stellen, ook als het voertuig veel in het stadsverkeer onderweg is en de motor vaak wordt uitgezet. Alleen de grote reserve van onze Promotive batterijen garandeert dat uitrustingen als een laadkraan altijd klaar voor gebruik zijn.

Touringcars



Betrouwbaarheid is van doorslaggevend belang voor het succesvol exploiteren van intercitydiensten. Ons Promotive assortiment biedt zelfs bij extreem weer buitengewone kracht, zodat uw passagiers gegarandeerd op tijd van A naar B komen. Bovendien verminderen onze onderhoudsvrije producten stilstandtijden waardoor uw totale kosten dalen. Ook andere aspecten ondersteunen uw concurrentiepositie door een grotere energievoorziening voor premium technologie zoals catering en entertainment aan boord.



Gemeentelijke voertuigen



Voertuigen in de publieke sector moeten extra kostenefficiënt zijn en altijd klaar staan voor gebruik. Daarom werden onze batterijen extra betrouwbaar gemaakt, start na start. En hoe langer ze meegaan, des te meer geld u bespaart.

Bussen



Voor bussen op lijndiensten is stiptheid een eerste vereiste. Daarom is het belangrijk om een batterij te hebben die 100% betrouwbaar is en die gemaakt is voor de continue cyclische belasting door veelvuldig stoppen. Onze Promotive batterijen verminderen niet alleen de stilstandtijden, wat minder bezwaren van passagiers en meer omzet kan betekenen, maar waarborgen ook de energieverzorging voor alle functies aan boord, inclusief digitale displays en airco.

Brandweerwagens



Voor een levensreddende service als een brandweerkazerne, moeten de voertuigen op ieder moment klaar staan. Dat hangt sterk met de batterijen samen en die van VARTA® zijn in elk geval een betrouwbare energiebron voor speciale voertuigen. Ze bieden altijd ruimschoots energie voor lieren, slangen, mobilifoons en andere essentiële uitrusting.

Bouwvoertuigen



Bouwvoertuigen moeten het beste werken onder de zwaarste omstandigheden, de ongebruikelijkste omgevingen en het slechtste weer. Ze hebben batterijen nodig met maximaal startvermogen gecombineerd met extreme tril- en lekbestendigheid, ook in het terrein. Omdat u op VARTA kunt vertrouwen, voorkomt u dure stilstand en kunt u gewoon doorwerken.

Landbouwmachines



Als u de vruchten van uw werk wilt plukken, hebt u meer nodig dan goed weer. U hebt ook voertuigen nodig die hun geld waard zijn, zelfs nadat ze een seizoen hebben stilgestaan. VARTA batterijen zijn precies hiervoor gemaakt, ze hebben een uitstekende startkracht en meer dan genoeg reserves voor alle voorzieningen in de cabine zoals de airco. En omdat onze producten onderhoudsvrij zijn, verlaagt u uw totale kosten elk seizoen verder.

Meer informatie over specifieke toepassingen van onze batterijen en de dichtstbijzijnde dealer vindt u op : www.varta-automotive.com

ECOSTEPS® IS EEN VERANTWOORDE, DUURZAME MANIER OM BATTERIJEN TE RECYCLEN

ecosteps®

is een recyclingprogramma van Johnson Controls waarmee gecertificeerde dealers en garages professionele recycling garanderen en daarmee een

bijdrage leveren aan milieubescherming. De gebruikte batterijen worden direct verwerkt in een effectief recyclingproces volgens de hoogste milieustandaards. Het recyclingproces ecosteps van Johnson Controls sluit de kringloop door het behoud van resources en de bescherming van het milieu. De deelname aan dit initiatief is eenvoudig, er is weinig administratie en het biedt financiële voordelen.

EEN GESLOTEN RECYCLINGPROCES

Gebruikte batterijen worden gerecycled tot nieuwe batterijen.

Johnson Controls haalt de gebruikte batterijen bij de groothandel op.



Johnson Controls levert nieuwe batterijen aan de groothandel.

De dealers krijgen nieuwe batterijen van de groothandel.

Nieuwe batterijen worden verkocht en ingebouwd. Gebruikte batterijen worden teruggegeven.

De groothandel zamelt de gebruikte batterijen van de dealer in.

Voor groothandel en werkplaatsen: een betere manier om batterijen te verkopen

Met ons initiatief ecosteps is het eenvoudig om uw inzet voor het milieu te tonen, te voldoen aan alle wettelijke regels, de winst te verhogen en lage prijzen aan te bieden. Nadat u zich heeft geregistreerd, hoeft u alleen nog de gebruikte batterijen op te slaan die u vervangt door nieuwe. Wij halen ze bij de volgende levering op en recyclen ze op een veilige en verantwoorde manier. En elke gebruikte batterij die u teruggeeft, helpt u om geld te besparen, want wij belonen uw inzet met lagere prijzen voor nieuwe VARTA® batterijen.

Meer over dit initiatief en de deelnemende landen vindt u op: www.varta-automotive.com

SPECIFICATIES

Of het nu een tweedehands auto is of een moderne truck, onze specificaties maken het voor u heel eenvoudig om de juiste batterij voor elke bedrijfswagen te vinden.



Promotive Silver met PowerFrame® roostertechnologie

VARTA® code	Kort nummer	Capaciteit (Ah)	Voltage	Koudstartstroom A (EN)	Buiten-afmetingen (mm)			Formaat	Gewicht (kg)	Schakelschema	Polen	Bodembevestiging
					L	B	H					
...A72 2												
725 103 115	N9	225	12V	1150	518	276	242	Typ C	58,10	3	1	B00
680 108 100	M18	180	12V	1000	513	223	223	Typ B	45,10	3	1	B00
645 400 080	K7	145	12V	800	513	189	223	Typ A	36,62	3	1	B00



Promotive Blue met PowerFrame® roostertechnologie

VARTA® code	Kort nummer	Capaciteit (Ah)	Voltage	Koudstartstroom A (EN)	Buiten-afmetingen (mm)			Formaat	Gewicht (kg)	Schakelschema	Polen	Bodembevestiging
					L	B	H					
...A73 2												
715 400 115	N7	215	12V	1150	518	276	242	Typ C	56,75	3	1	B00
670 104 100	M9	170	12V	1000	513	223	223	Typ B	44,20	3	1	B03
670 103 100	M8	170	12V	1000	513	223	223	Typ B	44,20	3	1	B00
640 400 080	K8	140	12V	800	513	189	223	Typ A	35,76	3	1	B03
640 103 080	K10	140	12V	800	513	189	223	Typ A	35,76	3	1	B00



Promotive Black met PowerFrame® roostertechnologie

VARTA® code	Kort nummer	Capaciteit (Ah)	Voltage	Koudstartstroom A (EN)	Buiten-afmetingen (mm)			Formaat	Gewicht (kg)	Schakelschema	Polen	Bodembevestiging
					L	B	H					
...A74 2												
720 018 115	N5	220	12V	1150	518	291	242	Typ C	56,79	3	1	B00
700 038 105	N2	200	12V	1050	518	276	242	Typ C	53,61	3	1	B00
680 033 110	M7	180	12V	1100	513	223	223	Typ B	44,99	4	1	B03
655 104 090	L5	155	12V	900	514	218	210	MAC 154	42,88	4	1	B03
655 013 090	L2	155	12V	900	513	223	223	Typ B	40,98	3	1	B00
643 107 090	K11	143	12V	900	508	174	205	MAC 132	36,50	0	1	B01
643 033 095	K4	143	12V	950	514	218	210	MAC 140	39,85	3	1	B03
635 052 100	J10	135	12V	1000	514	175	210	MAC 110	35,46	3	1	B03
635 042 068	J8	135	12V	680	360	253	240	12C135	42,30	6	1	B11
630 014 068	J5	130	12V	680	514	218	208	MAC 130	37,83	3	1	B00
625 023 000	J3	125	12V	950	286	269	230	Nato	36,80	2	1	B00



Promotive Black met PowerFrame® roostertechnologie – vervolg

VARTA® code	Kort nummer	Capaciteit (Ah)	Voltage	Koudstartstroom A (EN)	Buiten-afmetingen (mm)			Formaat	Gewicht (kg)	Schakelschema	Polen	Bodembevestiging
					L	B	H					
...A74 2												
625 014 072	J2	125	12V	720	345	172	285	WOR 7	31,22	1	1	B00
625 012 072	J1	125	12V	720	345	172	285	WOR 7	31,22	0	1	B00
620 109 076	I16	120	12V	760	510	175	235	MAC 120	35,12	4	1	B03
620 045 068	I8	120	12V	680	513	189	215	Typ A	33,64	3	1	B00
610 404 068	I18	110	12V	680	347	173	234	LOT 7	28,58	0	1	B01
610 050 085	I6	110	12V	850	413	175	220	Typ D	27,80	0	1	B03
610 048 068	I5	110	12V	680	347	173	234	LOT 7	28,58	1	1	B00
610 047 068	I4	110	12V	680	347	173	234	LOT 7	28,58	0	1	B00
610 013 076	I2	110	12V	760	514	175	210	MAC 110	32,31	3	1	B03
602 103 068	H14	102	12V	680	330	172	240	Gr 31	24,42	9	8	B01
602 102 068	H13	102	12V	680	330	172	240	Gr 31	24,42	9	1	B01
600 123 072	H9	100	12V	720	313	175	205	GB 28	24,90	0	1	B13
600 047 060	H5	100	12V	600	413	175	220	Typ D	26,70	0	1	B00
600 035 060	H4	100	12V	600	413	175	220	Typ D	27,43	1	1	B00
590 041 054	G2	90	12V	540	345	173	233	LOT 7	25,20	1	1	B00
590 040 054	G1	90	12V	540	345	173	233	LOT 7	25,20	0	1	B00
588 038 068	F10	88	12V	680	350	174	189	H8	21,00	0	1	B13
566 047 051	D33	66	12V	510	278	175	190	H6	16,80	0	1	B03
555 064 042	C20	55	12V	420	246	175	190	H5	14,20	0	1	B13
545 200 030	B39	45	12V	300	210	175	175	T4	11,05	0	1	B13
200 023 095	N12	200	6V	950	403	175	235	M6/7	31,00	0	20	B11
150 030 076	L14	150	6V	760	333	175	235	M5	23,80	0	1	B11
140 023 072	K13	140	6V	720	260	175	236	M4	19,50	0	1	B01
112 025 051	I11	112	6V	510	260	175	238	M4	16,50	0	1	B01
070 011 030	E29	70	6V	300	175	167	220	M1	9,35	0	1	B00

Technische afbeeldingen

Schakelschema

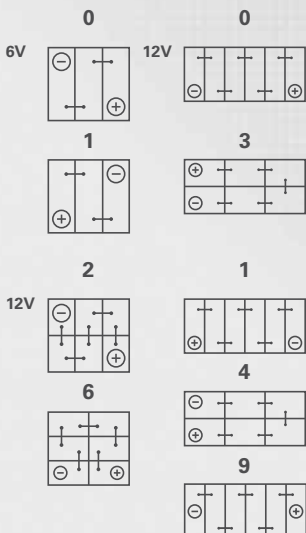

Polen

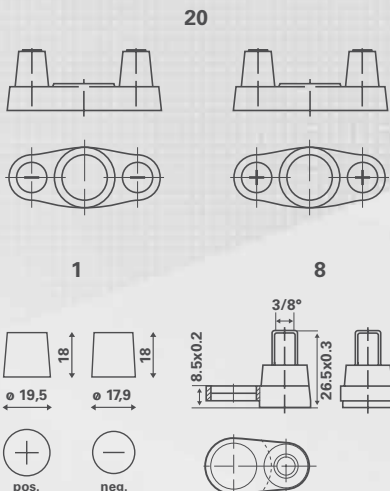

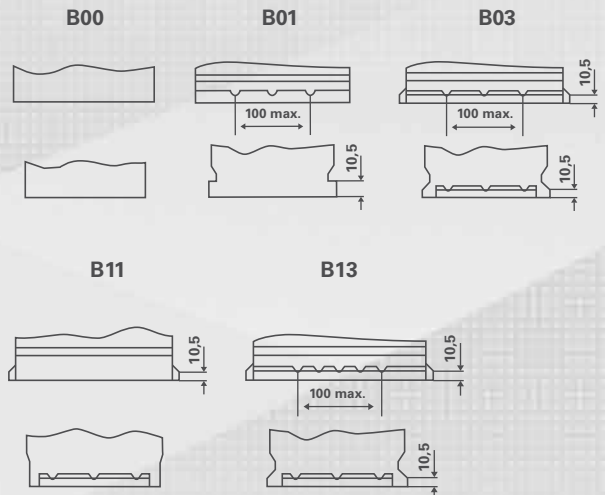

Bodembevestiging



OVER DEZE CATALOGUS

Aanwijzingen voor het gebruik van de catalogus

DAF > DODGE

 			Promotive Silver ... A72 2	Promotive Blue ... A73 2	Promotive Black ... A74 2
DAF					
F 2900	01/90 - 10/93				
FA/FAD/FAG/FAR/FAS/FMD/FT 2900		725 103 115 N9	670 103 100 M8	655 013 090 L2	
F 3200	01/90 - 10/93				
FA/FAB/FAD/FAR/FAS/FAT/FMD/FT 3200		725 103 115 N9	670 103 100 M8	655 013 090 L2	
F 3300	06/81 - 09/91				
FA/FAB/FAD/FAG/FAR/FAS/FAT/FT/FTG/ETS/ETD		725 103 115 N9	670 103 100 M8	655 013 090 L2	

D

- 1** Voertuigproducent, -model, -type (van A tot Z)
- 2** Bouwjaarindicatie van – tot
- 3** VARTA® productlijn, modelnummer

- 4** Korte code
- 5** VARTA code

We hebben dit handboek met de nodige zorgvuldigheid samengesteld. Maar vanwege het grote aantal voertuigtypes, die bovendien voortdurend worden gemoderniseerd, kan VARTA niet verantwoordelijk worden

gesteld als er een verkeerde batterij wordt gemonteerd. Deze verantwoordelijkheid ligt bij het monterende bedrijf en de specificaties van de voertuigproducent moeten worden aangehouden.

Voor een beter begrip van de Promotive etiketten







K7 12V 145Ah 800A (EN)
645 400 080 A72 2



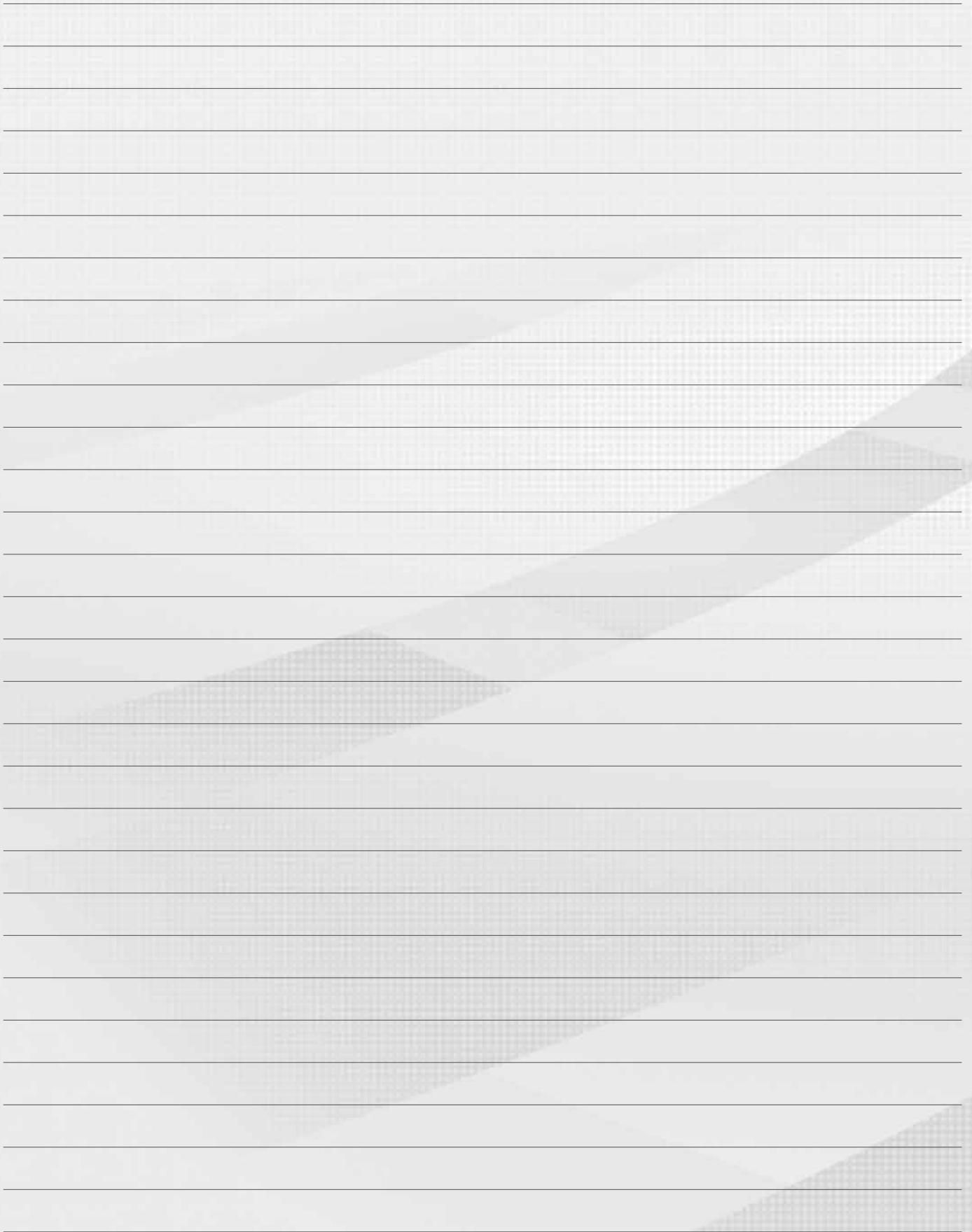

Johnson Controls



3
5
4





 			Promotive Silver ... A72 2	Promotive Blue ... A73 2	Promotive Black ... A74 2
AEC					
MAJOR TILT CAB					625 014 072 J2
MANDATOR					625 014 072 J2
MANDATOR MAJOR TILT CAB					625 014 072 J2
MARSHALL TILT CAB					625 014 072 J2
MERCURY TILT CAB					625 014 072 J2
MONARCH TILT CAB					625 014 072 J2
RANGER					610 048 068 I5
RANGER 4M4					625 014 072 J2
RELIANCE					610 404 068 I18 610 047 068 I4
SWIFT					610 404 068 I18 610 047 068 I4
ASTRA					
HD 7-C	01/00 →				
42.36 - 64.50		680 108 100 M18	670 103 100 M8	655 013 090 L2	
66.36 - 66.50		680 108 100 M18	670 103 100 M8	643 033 095 K4	
84.36 - 84.50		680 108 100 M18	670 103 100 M8	655 013 090 L2	
86.40 - 88.50		680 108 100 M18	670 103 100 M8	643 033 095 K4	
HD 7	01/96 →				
42.42 - 86.52		680 108 100 M18	670 103 100 M8	655 013 090 L2	
HD 8	01/05 →				
42.41 - 88.56		680 108 100 M18	670 103 100 M8	655 013 090 L2	
ATKINSON					
BORDERER TRACTOR T3246XBL, T3246RR					610 404 068 I18 610 047 068 I4
BORDERER TRACTOR T3446C, T3448XB					625 012 072 J1
DEFENDER HAUL L3086C, L3086CL					625 012 072 J1
DEFENDER HAUL L3086XL, L3086XBL					625 012 072 J1
DEFENDER TIPPER 2686XB					625 012 072 J1
DEFENDER TIPPER S2466X					610 404 068 I18 610 047 068 I4
DEFENDER TIPPER S3086C, S3086CL					625 012 072 J1
DEFENDER TIPPER S3086XBL, S3086XB					625 012 072 J1
SEARCHER HAUL 2466X					610 404 068 I18 610 047 068 I4
SEARCHER TIPPER S2466XL					610 404 068 I18 610 047 068 I4
VENTURA TRACTOR T4568XB, T4566C					625 012 072 J1
VENTURA TRACTOR T7566C, T7568XB					625 012 072 J1
AUWÄRTER (NEOPLAN)					
All models		725 103 115 N9	715 400 115 N7	700 038 105 N2	
AUWÄRTER					
302-Serie					
302-8		680 108 100 M18	670 103 100 M8	655 013 090 L2	
302-10, -11		680 108 100 M18	670 103 100 M8	655 013 090 L2	
302-12 Eurostar		680 108 100 M18	670 103 100 M8	655 013 090 L2	
302-13 Eurostar		680 108 100 M18	670 103 100 M8	655 013 090 L2	
800-Serie					
811-42		680 108 100 M18	670 103 100 M8	655 013 090 L2	
811-43		680 108 100 M18	670 103 100 M8	655 013 090 L2	
813-42		680 108 100 M18	670 103 100 M8	655 013 090 L2	
813-43		680 108 100 M18	670 103 100 M8	655 013 090 L2	
AVIA					
All 12 V vehicles					588 038 068 F10
D-Line	10/01 →				
D 100					588 038 068 F10
D 120					588 038 068 F10
D 60					588 038 068 F10

A

 			Promotive Silver ... A72 2	Promotive Blue ... A73 2	Promotive Black ... A74 2
AVIA					
D-Line	10/01 →				
D 75					588 038 068 <i>F10</i>
D 75 T					588 038 068 <i>F10</i>
D 90					588 038 068 <i>F10</i>
AWD					
TL					625 012 072 <i>J1</i>
TM					625 012 072 <i>J1</i>
Agrale					
Microbus					
MA 6.0 Euro II		645 400 080 <i>K7</i>	640 103 080 <i>K10</i>	620 045 068 <i>I8</i>	
MA 6.0 Euro III		645 400 080 <i>K7</i>	640 103 080 <i>K10</i>	620 045 068 <i>I8</i>	
MA 7.5 Euro II		645 400 080 <i>K7</i>	640 103 080 <i>K10</i>	620 045 068 <i>I8</i>	
MA 7.5 Euro III		645 400 080 <i>K7</i>	640 103 080 <i>K10</i>	620 045 068 <i>I8</i>	
MA 8.5 Euro II		680 108 100 <i>M18</i>	640 103 080 <i>K10</i>	620 045 068 <i>I8</i>	
MA 8.5 Euro III		645 400 080 <i>K7</i>	640 103 080 <i>K10</i>	620 045 068 <i>I8</i>	
MA 9.2 Euro II		680 108 100 <i>M18</i>	670 103 100 <i>M8</i>	655 013 090 <i>L2</i>	
MA 9.2 Euro III		645 400 080 <i>K7</i>	640 103 080 <i>K10</i>	620 045 068 <i>I8</i>	
MA 9.2 Green Euro III		680 108 100 <i>M18</i>	670 103 100 <i>M8</i>	655 013 090 <i>L2</i>	
Midibus					
MA 12.0 Euro II		680 108 100 <i>M18</i>	670 103 100 <i>M8</i>	655 013 090 <i>L2</i>	
BARKAS					
All models diesel		645 400 080 <i>K7</i>	640 103 080 <i>K10</i>	620 045 068 <i>I8</i>	
BEDFORD					
CF-Serie					
CF-serie D				610 048 068 <i>I5</i>	
CF 2/230 - 350				590 041 054 <i>G2</i>	
D-Serie					
D 7.5 T				588 038 068 <i>F10</i>	
M-Serie					
M TYPE 12V				140 023 072 <i>K13</i>	
M TYPE 24V				140 023 072 <i>K13</i>	
TJ-Serie					
TJ 220 - 1000				590 041 054 <i>G2</i>	
TK-Serie					
TK 220 - 1630				610 048 068 <i>I5</i>	
TL-Serie					
TL 500 - 3200				625 012 072 <i>J1</i>	
TM-Serie					
TM 6V7				625 012 072 <i>J1</i>	
TM 6V81				625 012 072 <i>J1</i>	
TM 8V71				625 012 072 <i>J1</i>	
TM 500 - 4400				625 012 072 <i>J1</i>	
Y-Serie					
YNT				140 023 072 <i>K13</i>	
YNV				610 404 068 <i>I18</i> 610 047 068 <i>I4</i>	
BERNA					
4VF, 4VM,			640 400 080 <i>K8</i>	643 033 095 <i>K4</i>	
D180			640 400 080 <i>K8</i>	643 033 095 <i>K4</i>	
D230, D290			640 400 080 <i>K8</i>	643 033 095 <i>K4</i>	
D330			640 400 080 <i>K8</i>	643 033 095 <i>K4</i>	
VFS					
5 VFS		645 400 080 <i>K7</i>	640 103 080 <i>K10</i>	620 045 068 <i>I8</i>	
VF					
5 VF		645 400 080 <i>K7</i>	640 103 080 <i>K10</i>	620 045 068 <i>I8</i>	

			Promotive Silver ... A72 2	Promotive Blue ... A73 2	Promotive Black ... A74 2
---	---	---	-------------------------------	-----------------------------	------------------------------



BERNA					
VM					
5 VM		645 400 080	K7	640 103 080	K10 620 045 068 I8
V					
5 V		645 400 080	K7	640 103 080	K10 620 045 068 I8
BOVA					
All models		725 103 115	N9	715 400 115	N7 700 038 105 N2
Futura	09/84 →				
FHD 10, FHD 12, FHD 13, FLD 12, FLD 13		725 103 115	N9	715 400 115	N7 700 038 105 N2
FHD 104, FHD 120, FHD 127, FLD 104, FLD 120, FLD 127		725 103 115	N9		
FHD 12, FHD 13		725 103 115	N9	715 400 115	N7 700 038 105 N2
FHD 14 Magnum, FLD 15 Magnum		725 103 115	N9	715 400 115	N7 700 038 105 N2
FLD 104, FLD 120, FLD 127		725 103 115	N9		
FLD 15 Magnum		725 103 115	N9	715 400 115	N7 700 038 105 N2
Lexio	09/05 →				
LD 123, LD 130		725 103 115	N9	715 400 115	N7 700 038 105 N2
LLD 123-310, LLD 130-310		725 103 115	N9	715 400 115	N7 700 038 105 N2
LLD 123-365, LLD 130-365		725 103 115	N9	715 400 115	N7 700 038 105 N2
Magiq	10/99 →				
HD 120, HD 122		725 103 115	N9	715 400 115	N7 700 038 105 N2
HD 131 Magnum, HD 139 Magnum		725 103 115	N9	715 400 115	N7 700 038 105 N2
MHD 122		725 103 115	N9		
MHD 131 Magnum, MHD 139 Magnum, MHD 148 Magnum		725 103 115	N9		
Synergy	09/04 →				
DD 130, DD 138		725 103 115	N9	715 400 115	N7 700 038 105 N2
SDD 130, SDD 141		725 103 115	N9	715 400 115	N7 700 038 105 N2
SDD 130, SSD 141		725 103 115	N9	715 400 115	N7 700 038 105 N2
BREMACH					
GR35, GR45, NB35, NB45					588 038 068 F10
GR-Serie					
GR35					588 038 068 F10
GR45					588 038 068 F10
NB-Serie					
NB35					588 038 068 F10
NB45					588 038 068 F10
BUESSING					
BS		645 400 080	K7	640 103 080	K10 620 045 068 I8
BS BUS		680 108 100	M18	670 103 100	M8 655 013 090 L2
KONSUL		680 108 100	M18	670 103 100	M8 655 013 090 L2
LKW OM, Burglöwe					610 404 068 I18 610 047 068 I4
PRÄFEKT, COMMODORE		680 108 100	M18	670 103 100	M8 655 013 090 L2
14-150 (24 V)		645 400 080	K7	640 103 080	K10 620 045 068 I8
AK					
14-150 (12 V), 14-185		680 108 100	M18	640 103 080	K10 620 045 068 I8
AK 14-150		680 108 100	M18	640 103 080	K10 620 045 068 I8
Supercargo					
L 14-185		680 108 100	M18	670 103 100	M8 655 013 090 L2
COMMER-KARRIER-DODGE					
K					
K2413T					610 048 068 I5
Andere					
100 Series					625 012 072 J1
300 Series		680 108 100	M18	670 103 100	M8 655 013 090 L2
50 Series					625 012 072 J1
LDA, LDU7					625 012 072 J1
LDV3					625 012 072 J1

 			Promotive Silver ... A72 2	Promotive Blue ... A73 2	Promotive Black ... A74 2
DAF					
45	01/91 - 12/00				
45.120 - 45.210					610 404 068 /18 610 047 068 /4
55	09/95 - 12/00				
55.150 - 55.230					625 012 072 /J1
65 CF	02/98 - 12/00				
65 CF 180 - 65 CF 240		680 108 100 M18	670 103 100 M8	655 013 090 L2	
65	01/93 - 02/98				
65.180 - 65.240		645 400 080 K7	640 103 080 K10	620 045 068 /8	
75 CF	02/98 - 12/00				
75 CF 250 - 75 CF 320		680 108 100 M18	670 103 100 M8	655 013 090 L2	
75	07/92 - 02/98				
75.240 - 75.300		680 108 100 M18	640 103 080 K10	620 045 068 /8	
85 CF	02/98 - 12/00				
85 CF 340 - 85 CF 430		725 103 115 N9	670 103 100 M8	655 013 090 L2	
85	07/92 - 02/98				
85.330 - 85.400		725 103 115 N9	670 103 100 M8	655 013 090 L2	
95 XF	01/97 - 09/02				
95 XF 380 - 95 XF 530		725 103 115 N9	670 103 100 M8	655 013 090 L2	
95	09/87 - 01/98				
95.310 - 95.500		725 103 115 N9	670 103 100 M8	655 013 090 L2	
CF 65	01/01 →				
65.180 - 65.290		680 108 100 M18	670 103 100 M8	655 013 090 L2	
CF 75	01/01 →				
75.250 - 75.360		680 108 100 M18	670 103 100 M8	655 013 090 L2	
CF 85	01/01 →				
85.340 - 85.510		680 108 100 M18	670 103 100 M8	655 013 090 L2	
F 1000					
FA 1000					610 404 068 /18 610 047 068 /4
F 1100					
FA 1100		645 400 080 K7	640 103 080 K10	620 045 068 /8	
F 1200					
FA 1200		645 400 080 K7	640 103 080 K10	620 045 068 /8	
F 1300					
FA 1300 / 1305		645 400 080 K7	640 103 080 K10	620 045 068 /8	
F 1400					
FA 1400		645 400 080 K7	640 103 080 K10	620 045 068 /8	
F 1500	07/78 →				
FA 1500		645 400 080 K7	640 103 080 K10	620 045 068 /8	
F 1600					
FA/FGG/FT 1600		645 400 080 K7	640 103 080 K10	620 045 068 /8	
F 1700					
FA/FAG/FD 1700		645 400 080 K7	640 103 080 K10	620 045 068 /8	
F 1800					
FAV 1800		645 400 080 K7	640 103 080 K10	620 045 068 /8	
F 1900					
FA/FAV/FD 1900		680 108 100 M18	670 103 100 M8	655 013 090 L2	
FA/FAV/FD/FT 1900		680 108 100 M18	670 103 100 M8	655 013 090 L2	
F 2100					
FA/FAG/FAS/FT 2100/2103/2105		680 108 100 M18	670 103 100 M8	655 013 090 L2	
F 2300	09/63 - 10/93				
FA/FAB/FAG/FAS/FAT/FAV/FMB/FMT 2300/2305		680 108 100 M18	670 103 100 M8	655 013 090 L2	
F 2500					
FA/FAD/FAG/FATFMD/FMT/FT 2500/2505/2525/2535		680 108 100 M18	670 103 100 M8	655 013 090 L2	
F 2700	01/90 - 10/93				
FA/FAB/FAG/FARFAT/FMT/FT 2700		680 108 100 M18	670 103 100 M8	655 013 090 L2	
F 2800	09/73 - 09/91				
FA/FAB/FAC/FAD/FAG/FAR/FAS/FAT/FMD/FT/FTS/FTT 2800/2803/2804/2805/2825		680 108 100 M18	670 103 100 M8	655 013 090 L2	



			Promotive Silver ... A72 2	Promotive Blue ... A73 2	Promotive Black ... A74 2
---	---	---	-------------------------------	-----------------------------	------------------------------



DAF					
F 2900	01/90 - 10/93				
FA/FAD/FAG/FAR/FAS/FMD/FT 2900		725 103 115 N9	670 103 100 M8	655 013 090 L2	
F 3200	01/90 - 10/93				
FA/FAB/FAD/FAR/FAS/FAT/FMD/FT 3200		725 103 115 N9	670 103 100 M8	655 013 090 L2	
F 3300	06/81 - 09/91				
FA/FAB/FAC/FAD/FAG/FAR/FAS/FAT/FT/FTG/FTS/FTT 3300/3303/3304/3305/3325		725 103 115 N9	670 103 100 M8	655 013 090 L2	
F 3600	06/85 - 09/91				
FA/FAC/FAG/FAR/FASFT/FTG/FTS/FTT 3600/3603/3604/3605/3625		725 103 115 N9	670 103 100 M8	655 013 090 L2	
F 600					
FA 600				610 404 068 I18 610 047 068 I4	
F 800					
FA 800				610 404 068 I18 610 047 068 I4	
F 900					
FA 900				610 404 068 I18 610 047 068 I4	
LF 45	01/01 →				
45.130 - 45.250				610 404 068 I18 610 047 068 I4	
LF 55	01/01 →				
55.170 - 55.290				625 012 072 J1	
N 2800					
N 2826		725 103 115 N9	715 400 115 N7	700 038 105 N2	
N 3300					
N 3326		725 103 115 N9	715 400 115 N7	700 038 105 N2	
XF 105	10/05 →				
105.410 - 105.510		725 103 115 N9	670 103 100 M8	655 013 090 L2	
XF 95	09/02 - 12/06				
95.380 - 95.530		725 103 115 N9	670 103 100 M8	655 013 090 L2	
DENNIS					
JAVELIN					
16-18		680 108 100 M18	670 103 100 M8	655 013 090 L2	
Dart					
Dart				610 404 068 I18 610 047 068 I4	
Delta					
1600				610 404 068 I18 610 047 068 I4	
2222				610 404 068 I18 610 047 068 I4	
Dominant					
Dominant				625 012 072 J1	
Maxim					
Maxim				625 012 072 J1	
Mercury					
Mercury				625 012 072 J1	
Pax					
Pax				625 012 072 J1	
Paxit					
Paxit II A				625 012 072 J1	
DODGE					
100 Series					
12 Ton Range (24V)				625 012 072 J1	
300 Series C 17T, 38T, 3864					
300 Series, C 2464, C 38T, 4084		725 103 115 N9	670 103 100 M8	655 013 090 L2	
300 Series, K 3820, R 3820P					
50 Series		725 103 115 N9	670 103 100 M8	655 013 090 L2	
				625 012 072 J1	



D

			Promotive Silver ... A72 2	Promotive Blue ... A73 2	Promotive Black ... A74 2
---	---	---	-------------------------------	-----------------------------	------------------------------

DODGE					
500 Series 12V					610 404 068 <i>I18</i> 610 047 068 <i>I4</i>
500 Series 24V					610 404 068 <i>I18</i> 610 047 068 <i>I4</i>
C4084		680 108 100 <i>M18</i>	670 103 100 <i>M8</i>		655 013 090 <i>L2</i>
CE range 12V					625 012 072 <i>J1</i>
CE range 24V					610 404 068 <i>I18</i> 610 047 068 <i>I4</i>
COMMANDO RANGE 12V					625 012 072 <i>J1</i>
COMMANDO RANGE 24V					625 012 072 <i>J1</i>
DKC range					610 048 068 <i>I5</i>
DVC range					625 012 072 <i>J1</i>
FBB					625 012 072 <i>J1</i>
FC					625 012 072 <i>J1</i>
G 08, G09, G10, G11, G12, G13					625 012 072 <i>J1</i>
G 14, G15, G16					625 012 072 <i>J1</i>
G 18, G20, G24, G26 (Tractor)					625 012 072 <i>J1</i>
K 1100 (Chrysler)					610 048 068 <i>I5</i>
K 3820					610 048 068 <i>I5</i>
K, KP range (Chrysler)					610 048 068 <i>I5</i>
K2413T					610 048 068 <i>I5</i>
Karrier Bantam FBH Diesel					625 012 072 <i>J1</i>
Karrier FB					625 012 072 <i>J1</i>
Karrier FC					625 012 072 <i>J1</i>
LDA, LDU7					625 012 072 <i>J1</i>
PBR Range					625 012 072 <i>J1</i>
S 35, 46, 56, 66 75 (4 cyl)					625 012 072 <i>J1</i>
VC Range (12V)					625 012 072 <i>J1</i>
VCA, VCF					625 012 072 <i>J1</i>
EBRO					
100 / 8D					588 038 068 <i>F10</i>
F260, F275					566 047 051 <i>D33</i>
F350					625 012 072 <i>J1</i>
L50, 60, 70 Turbo, 80					625 012 072 <i>J1</i>
P137					625 012 072 <i>J1</i>
P170, P190					625 012 072 <i>J1</i>
Trade 2, 0, 2, 8					566 047 051 <i>D33</i>
F-Serie					
F 100					566 047 051 <i>D33</i>
F 108					566 047 051 <i>D33</i>
F 260					566 047 051 <i>D33</i>
F 275					566 047 051 <i>D33</i>
F 350					566 047 051 <i>D33</i>
L-Serie					
L 35					588 038 068 <i>F10</i>
L 35 S, SF					588 038 068 <i>F10</i>
L 35.09					588 038 068 <i>F10</i>
L 45, F					588 038 068 <i>F10</i>
L 45.08					588 038 068 <i>F10</i>
L 50.09					588 038 068 <i>F10</i>
L 60					588 038 068 <i>F10</i>
L 60.09					588 038 068 <i>F10</i>
L 80					588 038 068 <i>F10</i>
L 80 Turbo					588 038 068 <i>F10</i>
L 80, F					588 038 068 <i>F10</i>
L 80.09					588 038 068 <i>F10</i>
L 80.14					588 038 068 <i>F10</i>
ENASA					
1000-Serie					
1061		725 103 115 <i>N9</i>	670 103 100 <i>M8</i>		655 013 090 <i>L2</i>

 			Promotive Silver ... A72 2	Promotive Blue ... A73 2	Promotive Black ... A74 2
ENASA					
1000-Serie					
1063			725 103 115 N9	670 103 100 M8	655 013 090 L2
1064			725 103 115 N9	670 103 100 M8	655 013 090 L2
1065 B			725 103 115 N9	670 103 100 M8	655 013 090 L2
1065-B/8			725 103 115 N9	670 103 100 M8	655 013 090 L2
1066			725 103 115 N9	670 103 100 M8	655 013 090 L2
EOS COACH					
All models			725 103 115 N9	715 400 115 N7	700 038 105 N2
ERF					
205, 220, 260T (Rolls Royce), 290					625 012 072 J1
31R4, 64 R 205, 64 R 220, 64 R 260T (Rolls Royce)					625 012 072 J1
84, 84PF, 84 PS, 84PV (Perkins)					625 012 072 J1
84, 84PF, 84PV (Perkins)					625 012 072 J1
86 PS Fire Appliance					625 012 072 J1
All models (Cummins)					610 404 068 I18 610 047 068 I4
All models (Gardner GX)					625 012 072 J1
All models (Gardner LW)					610 404 068 I18 610 047 068 I4
All models (Gardner LX, LXB)					625 012 072 J1
All models (Perkins)					610 404 068 I18 610 047 068 I4
CP Series					625 014 072 J2
L10					625 012 072 J1
TRAILBLAZER 32G46, 36RZ					625 012 072 J1
ECL	04/02 →				
6.22 - 7.28			680 108 100 M18	670 103 100 M8	655 013 090 L2
7.28			680 108 100 M18	670 103 100 M8	655 013 090 L2
ECM	04/02 →				
6.22 - 7.28			680 108 100 M18	670 103 100 M8	655 013 090 L2
ECT	04/02 →				
10.35 - 32.35			680 108 100 M18	670 103 100 M8	655 013 090 L2
Andere					
C Series					625 014 072 J2
E / EC Series			680 108 100 M18	670 103 100 M8	655 013 090 L2
F.T.F					
Alle Modelle			725 103 115 N9	670 103 100 M8	655 013 090 L2
FAR					
CM 54, 55, 56 V					588 038 068 F10
FAUN					
AK					
AK 414 HW			725 103 115 N9	715 400 115 N7	720 018 115 N5
L					
L 1212/45 ZA 6x6			725 103 115 N9	715 400 115 N7	720 018 115 N5
FBW					
All models			645 400 080 K7	640 103 080 K10	620 045 068 I8
FIAT					
AL					
418 AL				640 400 080 K8	635 052 100 J10
Daily					
28F8 - 40F8				640 400 080 K8	635 052 100 J10
E					
242 E					588 038 068 F10
F					
170F20 - 170F35				640 400 080 K8	643 033 095 K4



 			Promotive Silver ... A72 2	Promotive Blue ... A73 2	Promotive Black ... A74 2
FIAT					
F					
50F8 - 79F13					566 047 051 D33
NC					
110 NC					620 109 076 I16
130 NC - 170 NC				640 400 080 K8	620 045 068 I8
50 NC - 75 NC				640 400 080 K8	620 045 068 I8
NR					
130NR / 130 NT / 150 NR				640 400 080 K8	620 045 068 I8
NT					
130NR / 130 NT / 150 NR				640 400 080 K8	620 045 068 I8
NT 20				640 400 080 K8	620 045 068 I8
N					
619 N - 697 N					643 033 095 K4
PAC					
190 PAC 20 - 260 PAC 26				640 400 080 K8	620 045 068 I8
PC					
65 PC / 75 PC					566 047 051 D33
P					
170.35 T/TP/P					643 033 095 K4
TP					
170.35 T/TP/P					643 033 095 K4
T					
170.35 T/TP/P					643 033 095 K4
Andere					
159.17				640 400 080 K8	
170.35					643 033 095 K4
242					588 038 068 F10
70.10 / 79.13					566 047 051 D33
FODEN					
2000 Series					625 014 072 J2
3000 Series					625 014 072 J2
4000 Series					625 014 072 J2
ALL MODELS (Cummins NH220 Eng.)					625 014 072 J2
EFT CHASSIS (Leyland)					625 014 072 J2
ER					610 048 068 I5
FCU over 40 tons (Cummins)					610 048 068 I5
FE, FG, FLE models					610 048 068 I5
FLEETMASTER Range					625 014 072 J2
FR CHASSIS (Rolls Royce)					625 014 072 J2
HAULMASTER Range					610 048 068 I5
S 104, 106, 108					610 048 068 I5
S 83					610 404 068 I18 610 047 068 I4
Tilt Cab (Cummins)					610 048 068 I5
Tilt Cab (Gardner)					610 048 068 I5
Tilt Cab (Rolls Royce)					625 014 072 J2
Fleetmaster					
Fleetmaster					625 014 072 J2
Haulmaster					
Haulmaster					610 048 068 I5
S					
104, 106, 108					610 048 068 I5
83					610 048 068 I5
S104					610 048 068 I5
S106					610 048 068 I5
S108					610 048 068 I5
S83					610 048 068 I5
Tiltcab					
Cummins Engine					150 030 076 L14



			Promotive Silver ... A72 2	Promotive Blue ... A73 2	Promotive Black ... A74 2
---	---	---	-------------------------------	-----------------------------	------------------------------

FODEN					
Tiltcab					
Gardner Engine					610 048 068 I5
Gardner Motor					610 048 068 I5
Rolls Royce Motor					625 012 072 J1
Andere					
2000 Series					625 014 072 J2
3000 Series					625 014 072 J2
4000 Series					625 014 072 J2
FORD					
6AA, 6CA, 7AA (24V)					625 014 072 J2
BUS CHASSIS		645 400 080 K7	640 103 080 K10		620 045 068 I8
D & K PASSENGER					610 048 068 I5
D SERIES					610 048 068 I5
TRANSCONTINENTAL					625 012 072 J1
1013 - 3424					610 048 068 I5
CARGO SERIES					
413F, 413F2 (24V)					625 014 072 J2
1012 - 1115					610 048 068 I5
1215 - 3220					625 012 072 J1
608 - 915					610 048 068 I5
Cargo	04/81 →				
0609 -1215					610 048 068 I5
GINAF					
C2					
C2120/2121		680 108 100 M18	670 103 100 M8		655 013 090 L2
F					
F 160 - F 535		680 108 100 M18	670 103 100 M8		655 013 090 L2
G					
G 3229 - G5450		725 103 115 N9	670 103 100 M8		655 013 090 L2
KFS					
KFS 10 - 16		680 108 100 M18	670 103 100 M8		655 013 090 L2
X2					
X2219 - X2223		680 108 100 M18	670 103 100 M8		655 013 090 L2
X3					
X3232 - X3335		680 108 100 M18	670 103 100 M8		655 013 090 L2
X52					
X5250 - X5450		725 103 115 N9	670 103 100 M8		655 013 090 L2
X5350					
X5250 - X5450		725 103 115 N9	670 103 100 M8		655 013 090 L2
X54					
X5250 - X5450		725 103 115 N9	670 103 100 M8		655 013 090 L2
x4					
X4241 - X4446		680 108 100 M18	670 103 100 M8		655 013 090 L2
GMC					
7000		725 103 115 N9	670 103 100 M8		655 013 090 L2
INVINCIBLE MK III (Diesel)					625 012 072 J1
WHITE					610 048 068 I5
GUY					
BIG J 24V (Diesel)					625 014 072 J2
INVINCIBLE MK III (Diesel)					625 014 072 J2
T43 Landtrain					625 014 072 J2
HANOMAG HENSCHEL					
F					
F 150					600 047 060 H5
F 161 / F 162 / F163 / F 191 / F 192 / F 193		645 400 080 K7	640 103 080 K10		620 045 068 I8
F 20 / 25 / 30 / 35 Diesel					588 038 068 F10

F



HANOMAG HENSCHEL > IRISBUS

 			Promotive Silver ... A72 2	Promotive Blue ... A73 2	Promotive Black ... A74 2
HANOMAG HENSCHEL					
F					
F 203 / F 221 / F223 / F 262		645 400 080 K7	640 103 080 K10	620 045 068 I8	
F 40 / 45 B Diesel				600 047 060 H5	
F 45 V / 46 / 55 / 65 / 66 / 75 / 76 / 85 / 86		645 400 080 K7	640 103 080 K10	620 045 068 I8	
H					
H 161 / 191 / 261		645 400 080 K7	640 103 080 K10	620 045 068 I8	
HANOMAG RHEINST					
AL					
AL 28		645 400 080 K7	640 103 080 K10	600 047 060 H5	
Garant					
L, LL, EL, K		680 108 100 M18	670 103 100 M8	655 013 090 L2	
L					
L 28		645 400 080 K7	640 103 080 K10	600 047 060 H5	
Markant					
L, LL, K, S		680 108 100 M18	670 103 100 M8	655 013 090 L2	
HINO					
LA					
LA 620 KB 422				620 109 076 I16	
SH					
SH				655 104 090 L5	
Andere					
FH		680 108 100 M18	670 103 100 M8	655 013 090 L2	
FS, FY		680 108 100 M18	670 103 100 M8	655 013 090 L2	
FYIK				655 104 090 L5	
HB KY		645 400 080 K7	640 103 080 K10	620 045 068 I8	
HE		645 400 080 K7	640 103 080 K10	620 045 068 I8	
KB		680 108 100 M18	670 103 100 M8	655 013 090 L2	
KM KL KLR KR				610 048 068 I5	
KY		680 108 100 M18	670 103 100 M8	655 013 090 L2	
ZM		680 108 100 M18	670 103 100 M8	655 013 090 L2	
FD FE FF				620 109 076 I16	
IFA					
MULTICAR M24		645 400 080 K7	640 103 080 K10	620 045 068 I8	
IKARUS					
297.07		725 103 115 N9	670 103 100 M8	655 013 090 L2	
398.20		725 103 115 N9	670 103 100 M8	655 013 090 L2	
405		725 103 115 N9	670 103 100 M8	655 013 090 L2	
417		725 103 115 N9	670 103 100 M8	655 013 090 L2	
IRISBUS					
ACCESS BUS 127	01/02 →				
GX 127		725 103 115 N9	715 400 115 N7	700 038 105 N2	
GX 127 L		725 103 115 N9	715 400 115 N7	700 038 105 N2	
ARWAY	06/06 →				
12M, 12.8M		725 103 115 N9	715 400 115 N7	700 038 105 N2	
AXER	10/03 - 01/07				
12.8m		725 103 115 N9	715 400 115 N7	700 038 105 N2	
12m, 12.8m		725 103 115 N9	715 400 115 N7	700 038 105 N2	
Arway					
Arway		725 103 115 N9	715 400 115 N7	720 018 115 N5	
CITELIS	09/05 →				
12, LINE		725 103 115 N9	715 400 115 N7	700 038 105 N2	
18		725 103 115 N9	715 400 115 N7	700 038 105 N2	
18 CNG		725 103 115 N9	715 400 115 N7	700 038 105 N2	
CROSSWAY	06/06 →				
10.6m		725 103 115 N9	715 400 115 N7	700 038 105 N2	
10.6m, 12m, 12.8m		725 103 115 N9	715 400 115 N7	700 038 105 N2	



			Promotive Silver ... A72 2	Promotive Blue ... A73 2	Promotive Black ... A74 2
---	---	---	-------------------------------	-----------------------------	------------------------------

IRISBUS					
Citelis					
Citelis		725 103 115	N9	715 400 115	N7 720 018 115 N5
Crossway					
Crossway		725 103 115	N9	715 400 115	N7 720 018 115 N5
DAILY TOURYS					
16, 19	11/06 →				610 404 068 I18 610 047 068 I4
DOMINO					
2001	10/03 →	725 103 115	N9	715 400 115	N7 700 038 105 N2
HD		725 103 115	N9	715 400 115	N7 700 038 105 N2
HD, HDH		725 103 115	N9	715 400 115	N7 700 038 105 N2
Daily					
Daily					610 404 068 I18
EVADYS					
H 12m, 12.8m	10/03 →	725 103 115	N9	715 400 115	N7 700 038 105 N2
HD 12m		725 103 115	N9	715 400 115	N7 700 038 105 N2
Evadys					
Evadys		725 103 115	N9	715 400 115	N7 720 018 115 N5
RECREO					
12m, 12.8m	10/03 - 01/07	725 103 115	N9	715 400 115	N7 700 038 105 N2
IVECO FIAT					
100 / 130		645 400 080	K7	640 103 080	K10 620 045 068 I8
135.14 - 165.24		680 108 100	M18	670 103 100	M8 643 033 095 K4
170.23 - 220.36		680 108 100	M18	670 103 100	M8 655 013 090 L2
170.23 - 330.36		680 108 100	M18	670 103 100	M8 655 013 090 L2
170.23 - 330.36		680 108 100	M18	670 103 100	M8 655 013 090 L2
242					588 038 068 F10
54.12		645 400 080	K7	640 103 080	K10 620 045 068 I8
625					588 038 068 F10
645 / 650 / 655 / 662 / 672 / 673 / 683		645 400 080	K7	640 103 080	K10 620 045 068 I8
80NC/NR, 90NC					588 038 068 F10
IVECO MAGIRUS					
109-14					610 013 076 I2
110-13 / 110-15 / 110-17					643 033 095 K4
115-17		680 108 100	M18	670 103 100	M8 655 013 090 L2
120-13 / 120-16 / 120-17		680 108 100	M18	670 103 100	M8 655 013 090 L2
130-13 / 130-16					643 033 095 K4
135-14 - 340-34		680 108 100	M18	670 103 100	M8 655 013 090 L2
50-9 / 60-11 / 65-9 / 65-12					588 038 068 F10
75-9 - 95-14					610 013 076 I2
AHB 6x4 (220 PS)		680 108 100	M18	670 103 100	M8 655 013 090 L2
IVECO OM					
100, 120		645 400 080	K7	640 103 080	K10 620 045 068 I8 588 038 068 F10
IVECO UNIC					
100 NC, 100NR, 100PC		645 400 080	K7	640 103 080	K10 620 045 068 I8
109.14					610 013 076 I2
110 NC, 110PC, 110PCM		645 400 080	K7	640 103 080	K10 620 045 068 I8
110, 120, 130		645 400 080	K7	640 103 080	K10 620 045 068 I8
110.14		680 108 100	M18	670 103 100	M8 655 013 090 L2
115.14, 120.16, 135.17		680 108 100	M18	670 103 100	M8 655 013 090 L2
115.17, 190 P, 260 P		680 108 100	M18	670 103 100	M8 655 013 090 L2
130 NC, 130 NR, 130 NT		645 400 080	K7	640 103 080	K10 620 045 068 I8
130.16		680 108 100	M18	670 103 100	M8 655 013 090 L2
135.17		680 108 100	M18	670 103 100	M8 655 013 090 L2
140 NC, 140NR, 140NT		645 400 080	K7	640 103 080	K10 620 045 068 I8

IVECO UNIC > IVECO



			Promotive Silver ... A72 2	Promotive Blue ... A73 2	Promotive Black ... A74 2
---	---	---	--------------------------------------	------------------------------------	-------------------------------------

IVECO UNIC					
145.17		680 108 100	M18	670 103 100	M8 655 013 090 L2
150 NL, 150NR		645 400 080	K7	640 103 080	K10 620 045 068 I8
159 NC		645 400 080	K7	640 103 080	K10 620 045 068 I8
170 NC, 170NR, 170NT, 170U		645 400 080	K7	640 103 080	K10 620 045 068 I8
170 TS		645 400 080	K7	640 103 080	K10 620 045 068 I8
175.17		680 108 100	M18	670 103 100	M8 655 013 090 L2
190.24, .26, .30, .32, .33, .36, .38, .42, .48		680 108 100	M18	670 103 100	M8 655 013 090 L2
230 EURO		645 400 080	K7	640 103 080	K10 620 045 068 I8
240.36, 240.38		680 108 100	M18	670 103 100	M8 655 013 090 L2
260.25, 260.30		680 108 100	M18	670 103 100	M8 655 013 090 L2
300 TS		680 108 100	M18	670 103 100	M8 655 013 090 L2
330.30, 330.36		680 108 100	M18	670 103 100	M8 655 013 090 L2
35.1					588 038 068 F10
35.8					588 038 068 F10
40.8, 49.10					588 038 068 F10
65.10					588 038 068 F10
75 P, 75 PC (4x4)				640 400 080	K8
79.10					610 013 076 I2
79.14					610 013 076 I2
90 P				640 400 080	K8
IVECO					
EuroCargo	01/91 - 12/00				
100E15 - 100E21					610 404 068 I18 610 047 068 I4
100E17 tector - 110E25 tector					610 404 068 I18
120E15 - 180E27		680 108 100	M18	670 103 100	M8 610 404 068 I18 610 047 068 I4
120E17 tector - 190E30 tector		680 108 100	M18	670 103 100	M8 610 404 068 I18 640 400 080 K8
225E28 tector - 320E28 tector		680 108 100	M18	670 103 100	M8 655 013 090 L2
260E23 - 320E27		680 108 100	M18	670 103 100	M8 655 013 090 L2
60E10 - 95E21					610 404 068 I18 610 047 068 I4
60E13 tector - 90E22 tector					610 404 068 I18
EuroStar	01/93 - 02/02				
LD 190E38 - 440E52		725 103 115	N9	670 103 100	M8 655 013 090 L2
EuroTech MH	09/98 →				
180E24 - 440E43		680 108 100	M18	670 103 100	M8 655 013 090 L2
EuroTech MP	01/92 →				
180E24 - 440E43		680 108 100	M18	670 103 100	M8 655 013 090 L2
EuroTech MT	01/92 - 08/98				
180E24 - 440E43		680 108 100	M18	670 103 100	M8 655 013 090 L2
EuroTrakker	01/93 - 11/04				
MP 190E30 - 260E44		680 108 100	M18	670 103 100	M8 655 013 090 L2
MP 340E34 - 720E47		725 103 115	N9	670 103 100	M8 655 013 090 L2
MK	01/83 - 12/91				
75-9 - 130-16					643 033 095 K4 610 013 076 I2
M	06/82 - 12/92				
115-17 - 175-24		680 108 100	M18	670 103 100	M8 655 013 090 L2
P/PA-Haubenfahrzeuge	12/79 - 12/93				
120-13 - 330-30		680 108 100	M18	670 103 100	M8 655 013 090 L2
P/PA	12/79 - 12/93				
159-17 - 340-34		680 108 100	M18	670 103 100	M8 655 013 090 L2
Stralis	02/02 →				
AD/AT 190S27 - 260S45		725 103 115	N9	670 103 100	M8 655 013 090 L2
AD/AT 440S40 - 440S45					720 018 115 N5
AS 190S40 - 260S56		725 103 115	N9	670 103 100	M8 655 013 090 L2
AS/AT 440S40 - 440S56					720 018 115 N5
Trakker	10/04 →				
AD/AT 180T27 - 720T50		725 103 115	N9	715 400 115	N7 720 018 115 N5



			Promotive Silver ... A72 2	Promotive Blue ... A73 2	Promotive Black ... A74 2
IVECO					
TurboStar	07/84 - 12/93				
190-33 - 190-48		680 108 100	M18	670 103 100	M8 655 013 090 L2
TurboTech	01/90 - 01/93				
190-26 - 240-36		680 108 100	M18	670 103 100	M8 655 013 090 L2
Zeta	01/79 - 12/92				
109-14					610 013 076 I2
50-8 - 65-12					588 038 068 F10
50-8 - 65-12					588 038 068 F10
79-10 - 95-14					610 013 076 I2
JELCZ					
All models		680 108 100	M18	670 103 100	M8 655 013 090 L2
JONCKHEERE					
12 V		725 103 115	N9	670 103 100	M8 655 013 090 L2
24 V		680 108 100	M18	670 103 100	M8 655 013 090 L2
KHD					
M					
110D7 - 160D16					600 047 060 H5
170D10 - 170D24				640 400 080	K8
180R12				640 400 080	K8
200SH110		680 108 100	M18	670 103 100	M8 655 013 090 L2
230L/R/TL/TR				640 400 080	K8
KÄSSBOHRER					
SETRA					
260 DW				640 400 080	K8 610 013 076 I2
S 10 - 14		680 108 100	M18	670 103 100	M8 655 013 090 L2
S 100 - 150		680 108 100	M18	670 103 100	M8 655 013 090 L2
S 200, 208 - 216		680 108 100	M18	670 103 100	M8 655 013 090 L2
S 228		680 108 100	M18	670 103 100	M8 655 013 090 L2
S 300, 309 - 315		680 108 100	M18	670 103 100	M8 655 013 090 L2
S 7 - 9		680 108 100	M18	670 103 100	M8 655 013 090 L2
SG 175/180		680 108 100	M18	670 103 100	M8 655 013 090 L2
S					
S 100 - 150		680 108 100	M18	670 103 100	M8 655 013 090 L2
LEYLAND					
BX					
BX 984					625 012 072 J1
BX 1000 - 1600					625 012 072 J1
BX 16 TF - 20TF					625 012 072 J1
Bison					
Bison 2					625 014 072 J2
Bison BN					610 048 068 I5
Bufallo					
Bufallo 2					625 014 072 J2
Bufallo BU					610 048 068 I5
Chieftain					
Chieftain					610 048 068 I5
Clydesdale					
Clydesdale					610 048 068 I5
Constructor					
T45, 100					625 012 072 J1
Cruiser					
T45					625 012 072 J1
EA					
EA Vans D					625 014 072 J2
EV Van (Diesel)					
EV Van (Diesel)					625 012 072 J1

J

LEYLAND

			Promotive Silver ... A72 2	Promotive Blue ... A73 2	Promotive Black ... A74 2
---	---	---	--------------------------------------	------------------------------------	-------------------------------------



LEYLAND					
Eland					610 048 068 <i>I5</i>
Eland					
FAD					625 012 072 <i>J1</i>
FAD 80.260 - 300					
FAD 85.300/330		725 103 115 <i>N9</i>	670 103 100 <i>M8</i>		655 013 090 <i>L2</i>
FAS					
FAS 2300/2700		680 108 100 <i>M18</i>	670 103 100 <i>M8</i>		655 013 090 <i>L2</i>
FAS 75.240					625 012 072 <i>J1</i>
FAT					
FAT 75.240 - 270					625 012 072 <i>J1</i>
FA					
FA 2300/2700		680 108 100 <i>M18</i>	670 103 100 <i>M8</i>		655 013 090 <i>L2</i>
FA 45.120 - 65.210					610 404 068 <i>I18</i> 610 047 068 <i>I4</i>
FF					
FF					140 023 072 <i>K13</i>
FG					
FG (2, 2 & 2, 5 l)					610 404 068 <i>I18</i> 610 047 068 <i>I4</i>
FG (3, 8; 4, 8; 5, 1 l)					625 012 072 <i>J1</i>
FJ					
FJ					140 023 072 <i>K13</i>
FM					
FM (2, 2 & 2, 5 l)					610 404 068 <i>I18</i> 610 047 068 <i>I4</i>
FTG					
FTG 80.330					625 012 072 <i>J1</i>
FTG 85.330 - 95.430		725 103 115 <i>N9</i>	670 103 100 <i>M8</i>		655 013 090 <i>L2</i>
FT					
FT 2300/2700/3200		680 108 100 <i>M18</i>	670 103 100 <i>M8</i>		655 013 090 <i>L2</i>
FT 75.270 - 80.330					625 012 072 <i>J1</i>
FT 85.330 - 95.430		725 103 115 <i>N9</i>	670 103 100 <i>M8</i>		655 013 090 <i>L2</i>
Freighter					
Freighter 12 V					610 404 068 <i>I18</i> 610 047 068 <i>I4</i>
Freighter 24 V					625 012 072 <i>J1</i>
Handyman					
Handyman					610 404 068 <i>I18</i> 610 047 068 <i>I4</i>
JU					
JU J4 D					610 048 068 <i>I5</i>
Landmaster					
T68					625 012 072 <i>J1</i>
Landtrain					
T43					625 012 072 <i>J1</i>
Marthon					
2					625 014 072 <i>J2</i>
T 45 Roadtrain Range					
17.27 - 20.33					625 012 072 <i>J1</i>
Andere					
145 Turbo					610 404 068 <i>I18</i> 610 047 068 <i>I4</i>
80 Series					625 012 072 <i>J1</i>
All BX & TR Models					625 012 072 <i>J1</i>
BEAR					610 048 068 <i>I5</i>
BOXER 1200, 1300, 1300 TV, BX					625 012 072 <i>J1</i>
COMET (Tilt Cab)					610 048 068 <i>I5</i>
FREIGHTER T203/207/500					610 404 068 <i>I18</i> 610 047 068 <i>I4</i>
LAIRD					610 404 068 <i>I18</i> 610 047 068 <i>I4</i>
MARATHON					625 014 072 <i>J2</i>
MASTIFF					625 012 072 <i>J1</i>



			Promotive Silver ... A72 2	Promotive Blue ... A73 2	Promotive Black ... A74 2
---	---	---	-------------------------------	-----------------------------	------------------------------

LEYLAND					
Andere					
MS Models					625 012 072 J1
OCTOPUS					625 012 072 J1
RETRIEVER					625 012 072 J1
ROAD RUNNER (T211/T45)					610 404 068 I18 610 047 068 I4
ROADTRAIN (T 45 Series)					625 012 072 J1
SUPER COMET (Tilt Cab)					610 404 068 I18 610 047 068 I4
SUPER MASTIFF					625 012 072 J1
TERRIER (TR)					625 012 072 J1
WF (3.8 & 4.8 Litre)					625 012 072 J1
WF (5.1 & 6.98 Litre)					625 012 072 J1
WF(2.2 & 2.5 Litre)					610 404 068 I18 610 047 068 I4
11.14 - 14.14					625 012 072 J1
17.27 - 26.26					625 012 072 J1
6.12 - 8.13					625 012 072 J1
FF, FJ					625 012 072 J1
FG, FM					625 012 072 J1
MANDATOR					625 014 072 J2
MAGIRUS-DEUTZ					
Bus					
E113				640 400 080 K8	635 052 100 J10
M2000 / R016				670 104 100 M9	
R/L 80/81					588 038 068 F10
SH 105/110/120/170		725 103 115 N9		670 103 100 M8	655 013 090 L2
T/L 117				640 400 080 K8	643 033 095 K4
TL/L/TR/R 100/120				640 400 080 K8	643 033 095 K4
D					
100D / 120D / 130D		680 108 100 M18		670 103 100 M8	655 013 090 L2
160D					610 050 085 I6
170D				640 400 080 K8	635 052 100 J10
232D / 256D / 270D / 310D / 340D		680 108 100 M18		670 103 100 M8	655 013 090 L2
75D / 80D		680 108 100 M18		670 103 100 M8	655 013 090 L2
85D / 90D / 135D				640 400 080 K8	635 052 100 J10
L					
260L117				640 400 080 K8	643 033 095 K4
M					
120R80					588 038 068 F10
130D / 160D / 168M					600 047 060 H5
130M / 160M / 168M		680 108 100 M18		670 103 100 M8	643 033 095 K4
170D				640 400 080 K8	
170SH110 / 200SH100		725 103 115 N9		670 103 100 M8	655 013 090 L2
192M				640 400 080 K8	
256M		680 108 100 M18		670 103 100 M8	655 013 090 L2
290M / 320M		680 108 100 M18		670 103 100 M8	655 013 090 L2
90D					600 047 060 H5
90M				640 400 080 K8	635 052 100 J10
90M				640 400 080 K8	
R					
130R81					588 038 068 F10
SH					
230SH110		725 103 115 N9		670 103 100 M8	655 013 090 L2
Andere					
126D / 130D / 135D / 150D				640 400 080 K8	
126D / 130D / 135D / 150D				640 400 080 K8	
130D					588 038 068 F10
160D					610 050 085 I6
170D				640 400 080 K8	
170L/R/TL/TR				640 400 080 K8	643 033 095 K4
180D		680 108 100 M18		670 103 100 M8	655 013 090 L2

M

MAGIRUS-DEUTZ > MAN



 			Promotive Silver ... A72 2	Promotive Blue ... A73 2	Promotive Black ... A74 2
MAGIRUS-DEUTZ					
Andere					
192D / 195D				640 400 080 <i>K8</i>	
200D				640 400 080 <i>K8</i>	
200L/R/TL/TR				640 400 080 <i>K8</i>	643 033 095 <i>K4</i>
210D / 230D		680 108 100 <i>M18</i>		670 103 100 <i>M8</i>	655 013 090 <i>L2</i> 643 033 095 <i>K4</i>
230L/R/TL/TR				640 400 080 <i>K8</i>	643 033 095 <i>K4</i>
232D / 235D / 256D / 290D / 310D		680 108 100 <i>M18</i>		670 103 100 <i>M8</i>	655 013 090 <i>L2</i> 643 033 095 <i>K4</i>
320M		680 108 100 <i>M18</i>		670 103 100 <i>M8</i>	655 013 090 <i>L2</i>
80D		680 108 100 <i>M18</i>		670 103 100 <i>M8</i>	655 013 090 <i>L2</i>
MAN					
E 2000	05/00 →				
E 2000		680 108 100 <i>M18</i>		670 103 100 <i>M8</i>	655 013 090 <i>L2</i>
EL	01/93 - 01/01				
EL 202/222/262		725 103 115 <i>N9</i>			
EM	08/87 →				
EM 192/222/223		680 108 100 <i>M18</i>		670 103 100 <i>M8</i>	655 013 090 <i>L2</i>
F 2000	01/94 →				
19.233 - 41.464		680 108 100 <i>M18</i>		670 103 100 <i>M8</i>	655 013 090 <i>L2</i>
F 90 Unterflur	06/86 - 09/96				
19.322 - 26.422		645 400 080 <i>K7</i>		640 103 080 <i>K10</i>	620 045 068 <i>I8</i>
F 90	06/86 - 12/97				
19.242 - 19.502		680 108 100 <i>M18</i>		640 103 080 <i>K10</i>	620 045 068 <i>I8</i>
24.242 - 48.462		680 108 100 <i>M18</i>		670 103 100 <i>M8</i>	655 013 090 <i>L2</i>
G 90	09/87 - 05/95				
6.100 - 10.150		645 400 080 <i>K7</i>		640 103 080 <i>K10</i>	620 045 068 <i>I8</i>
G	10/79 - 08/88				
6.90 - 10.136		645 400 080 <i>K7</i>		640 103 080 <i>K10</i>	620 045 068 <i>I8</i>
L 2000	10/93 →				
8.103 - 12.225		645 400 080 <i>K7</i>		640 103 080 <i>K10</i>	620 045 068 <i>I8</i>
LIONS COMFORT	09/96 →				
RN		725 103 115 <i>N9</i>			
LION'S CITY	01/04 →				
Lion's City		725 103 115 <i>N9</i>			
LION'S COACH	09/95 →				
FRH/RH/RHC		725 103 115 <i>N9</i>			
LION'S STAR	03/91 →				
FRH/RH/RHS		725 103 115 <i>N9</i>			
M 2000 L	08/95 →				
12.145 - 26.284		680 108 100 <i>M18</i>		640 103 080 <i>K10</i>	620 045 068 <i>I8</i>
M 2000 M	08/95 - 12/05				
12.224 - 25.284		680 108 100 <i>M18</i>		640 103 080 <i>K10</i>	620 045 068 <i>I8</i>
M 90	08/88 - 12/98				
12.152 - 24.272		680 108 100 <i>M18</i>		640 103 080 <i>K10</i>	620 045 068 <i>I8</i>
NG	08/92 →				
NG 262/263/272/312/313		680 108 100 <i>M18</i>			
NL	09/88 →				
NL 202 - 313		680 108 100 <i>M18</i>			
NM	08/87 →				
NM 152		645 400 080 <i>K7</i>		640 103 080 <i>K10</i>	635 052 100 <i>J10</i>
NM 182/192/222/223		680 108 100 <i>M18</i>			
NÜ	03/96 →				
NÜ 263/313/353		680 108 100 <i>M18</i>			
R	05/85 - 01/93				
R/FR/FRH 292/362		725 103 115 <i>N9</i>			
SD	04/74 - 04/94				
SD 200		680 108 100 <i>M18</i>			
SD 202		725 103 115 <i>N9</i>			

			Promotive Silver ... A72 2	Promotive Blue ... A73 2	Promotive Black ... A74 2
---	---	---	-------------------------------	-----------------------------	------------------------------

MAN					
SG	09/72 →				
SG 220/240/242/292/312/322		680 108 100	M18		
SL II	04/84 - 05/96				
SL 202		680 108 100	M18		
SL	06/72 - 04/87				
SL 200		680 108 100	M18		
SM	08/87 →				
SM 152		645 400 080	K7	640 103 080	K10 635 052 100 J10
SM 182/192		680 108 100	M18		
SR	02/75 - 08/94				
SR 240/280/321		680 108 100	M18		
SÜ	10/75 →				
SÜ 240/242/263/272/283/292/313/322		680 108 100	M18		
TGA	03/00 →				
18.310 - 19.480		680 108 100	M18	670 103 100	M8 655 013 090 L2
24.350 - 41.660		725 103 115	N9	670 103 100	M8 655 013 090 L2
TGL	04/05 →				
7.150 - 12.250		645 400 080	K7	640 103 080	K10 588 038 068 F10
TGM	10/05 →				
12.240 - 26.340		680 108 100	M18	640 103 080	K10 620 045 068 I8
TGS	08/07 →				
18.320 - 18.540		680 108 100	M18	670 103 100	M8 655 013 090 L2
24.320 - 41.540		725 103 115	N9	670 103 100	M8 655 013 090 L2
TGX	09/07 →				
18.360 - 18.540		680 108 100	M18	670 103 100	M8 655 013 090 L2
24.360 - 41.680		725 103 115	N9	670 103 100	M8 655 013 090 L2
ÜL	09/89 →				
ÜL 242/272/292/312/313/322/353		680 108 100	M18		
MAS					
All models		680 108 100	M18	670 103 100	M8 655 013 090 L2
MEILI					
MD1000, MD1001					610 404 068 I18 610 047 068 I4
MERCEDES-BENZ					
ACTROS MP2	10/02 →				
1832 - 5048		725 103 115	N9	670 103 100	M8
ATEGO 2	01/04 →				
712 - 1624		680 108 100	M18	640 103 080	K10 620 045 068 I8
ATEGO	01/98 - 10/04				
712 - 2628		680 108 100	M18	640 103 080	K10 620 045 068 I8
AXOR 2	10/04 →				
1823 - 3343		725 103 115	N9	670 103 100	M8
AXOR	09/01 - 10/04				
1823 - 3228		725 103 115	N9	670 103 100	M8
CITARO (O 530)	01/98 →				
Citaro G/NG/GNG/L/N		725 103 115	N9		
CITO (O 520)	09/98 →				
O520		725 103 115	N9		
CONECTO (O 345)	11/01 →				
CONECTO C/H/M/UE		725 103 115	N9		
ECONIC	03/98 →				
1823 - 3233		725 103 115	N9	670 103 100	M8
LK/LN2	01/84 - 12/98				
709 - 2024				640 400 080	K8 588 038 068 F10
LP	09/63 - 12/84				
608 - 1113				640 400 080	K8 588 038 068 F10

M

MERCEDES-BENZ > MULTICAR



 			Promotive Silver ... A72 2	Promotive Blue ... A73 2	Promotive Black ... A74 2
MERCEDES-BENZ					
MB-TRAC	07/73 - 12/91				
1300 - 1800		725 103 115 N9	670 103 100 M8	655 013 090 L2	
700/800		645 400 080 K7	640 103 080 K10	620 045 068 I8	
900/1000/1100		680 108 100 M18	670 103 100 M8	655 013 090 L2	
900/1000/1100		680 108 100 M18	640 103 080 K10	620 045 068 I8	
MK	12/87 - 09/96				
1222 - 2534		680 108 100 M18	640 103 080 K10	620 045 068 I8	
NG	08/73 - 09/96				
1013 - 3836		680 108 100 M18	640 103 080 K10	620 045 068 I8	
O 305	09/67 - 07/77				
O305 G/ST		725 103 115 N9	670 103 100 M8	655 013 090 L2	
O 307	04/73 - 12/87				
O 307		725 103 115 N9	670 103 100 M8	655 013 090 L2	
O 340	01/91 - 06/95				
Tourismo		725 103 115 N9			
O 404	09/91 - 10/99				
O 404		725 103 115 N9	670 103 100 M8		
O 405	09/84 →				
O 405		725 103 115 N9	670 103 100 M8		
O 407	03/87 - 11/01				
O 407		725 103 115 N9	670 103 100 M8		
SK	07/87 - 09/96				
1728 - 4850		680 108 100 M18	640 103 080 K10	620 045 068 I8	
TOURINO (O 510)	10/03 →				
Tourino		725 103 115 N9			
TOURISMO (O 350)	09/94 →				
Tourismo		725 103 115 N9			
TOURO (O 500)	10/01 →				
Tuoro		725 103 115 N9			
TRAVEGO (O 580)	10/99 →				
O 580		725 103 115 N9			
UNIMOG	01/66 →				
U 3000/4000/5000				600 047 060 H5 566 047 051 D33	
MITSUBISHI					
Canter	10/97 →				
Canter 35				610 048 068 I5	
Canter 55				610 048 068 I5	
Canter 60				610 048 068 I5	
Canter 75				610 048 068 I5	
MOWAG					
A8				566 047 051 D33	
B-300				566 047 051 D33	
MULTICAR					
M25	01/78 - 12/92				
1, 9		645 400 080 K7	640 103 080 K10	588 038 068 F10	
2, 2		645 400 080 K7	640 103 080 K10	588 038 068 F10	
M26	06/92 - 09/10				
1, 9				588 038 068 F10	
2, 5				588 038 068 F10	
2, 8				588 038 068 F10	
EcoLine, ProfilLine				588 038 068 F10	
TransLine				588 038 068 F10	
Tremo	09/98 →				
501				588 038 068 F10	
601				588 038 068 F10	
Carrier, Carrier S				588 038 068 F10	



			Promotive Silver ... A72 2	Promotive Blue ... A73 2	Promotive Black ... A74 2
---	---	---	-------------------------------	-----------------------------	------------------------------

MULTICAR					
UX100	01/99 →				
UX100H, UX100M					588 038 068 F10
UX100M					588 038 068 F10
NEOPLAN					
Centroliner	10/98 →				
N 4407 - 4421		680 108 100 M18		670 103 100 M8	
Cityliner	04/73 →				
N 116/1216		725 103 115 N9		670 103 100 M8	
Euroliner	10/98 →				
N 3316/3318		725 103 115 N9		670 103 100 M8	
Jetliner	09/73 - 09/93				
N 208/213/214/216		680 108 100 M18		670 103 100 M8	
Skyliner	09/73 →				
N122		725 103 115 N9		715 400 115 N7	720 018 115 N5
Spaceliner	09/79 →				
N 117		725 103 115 N9		715 400 115 N7	720 018 115 N5
Starliner	09/96 →				
N 516 / 5218		725 103 115 N9		715 400 115 N7	720 018 115 N5
Tourliner	09/02 →				
N 2216		725 103 115 N9		715 400 115 N7	720 018 115 N5
Transliner	12/88 →				
N 314/316/321		725 103 115 N9		670 103 100 M8	
Trendliner	09/04 →				
N 3516		725 103 115 N9		715 400 115 N7	720 018 115 N5
NISSAN					
ATLEON(110.56, 140.70)					588 038 068 F10
ATLEON(12.35, 120.56)					588 038 068 F10
ATLEON(140.75, 165.75)					610 404 068 I18 610 047 068 I4
L50 - 90					610 404 068 I18 610 047 068 I4
ATLEON	09/00 →				
110.35, 120.35					588 038 068 F10
110.56, 120.56					610 404 068 I18 610 047 068 I4
140.75					610 404 068 I18 610 047 068 I4
165.75					610 404 068 I18 610 047 068 I4
OTOMARSAN					
O					
O 302		645 400 080 K7		640 103 080 K10	620 045 068 I8
PEGASO					
1100, 1101/1					588 038 068 F10
1121, 1126					588 038 068 F10
1130, 1135, 1136					588 038 068 F10
1210/6, 1214, 1215.8, 1215.9, 1216					588 038 068 F10
1223		680 108 100 M18		670 103 100 M8	655 013 090 L2
1223 T		680 108 100 M18		670 103 100 M8	655 013 090 L2
1226		680 108 100 M18		670 103 100 M8	655 013 090 L2
1231 R		680 108 100 M18		670 103 100 M8	655 013 090 L2
1234 T		680 108 100 M18		670 103 100 M8	655 013 090 L2
1236		680 108 100 M18		670 103 100 M8	655 013 090 L2
2321 K2323 K		680 108 100 M18		670 103 100 M8	655 013 090 L2
2331 K, 2331 R, 2331 T, 2334,		680 108 100 M18		670 103 100 M8	655 013 090 L2
2426 K,		680 108 100 M18		670 103 100 M8	655 013 090 L2
2431 K		680 108 100 M18		670 103 100 M8	655 013 090 L2
3041, 3045/20, 3045/40, 3050					588 038 068 F10
3560					588 038 068 F10

N

PEGASO > RENAULT TRUCKS



 			Promotive Silver ... A72 2	Promotive Blue ... A73 2	Promotive Black ... A74 2
PEGASO					
360			680 108 100 <i>M18</i>	670 103 100 <i>M8</i>	655 013 090 <i>L2</i>
5068					588 038 068 <i>F10</i>
75					588 038 068 <i>F10</i>
COMET1091					588 038 068 <i>F10</i>
COMET1098					588 038 068 <i>F10</i>
EKUS 100 Turbo					588 038 068 <i>F10</i>
J4 1100					588 038 068 <i>F10</i>
J4 800					588 038 068 <i>F10</i>
RENAULT TRUCKS					
B	01/83 - 09/95				
70/90/110					588 038 068 <i>F10</i>
Berliet					
130			680 108 100 <i>M18</i>	670 103 100 <i>M8</i>	643 033 095 <i>K4</i>
150			680 108 100 <i>M18</i>	670 103 100 <i>M8</i>	643 033 095 <i>K4</i>
90			645 400 080 <i>K7</i>	640 103 080 <i>K10</i>	620 045 068 <i>I8</i>
C 210 - 380			680 108 100 <i>M18</i>	670 103 100 <i>M8</i>	643 033 095 <i>K4</i>
G 170 - 380			680 108 100 <i>M18</i>	670 103 100 <i>M8</i>	643 033 095 <i>K4</i>
GB 131/191			645 400 080 <i>K7</i>	640 103 080 <i>K10</i>	620 045 068 <i>I8</i>
GC 191			645 400 080 <i>K7</i>	640 103 080 <i>K10</i>	620 045 068 <i>I8</i>
GF 191			645 400 080 <i>K7</i>	640 103 080 <i>K10</i>	620 045 068 <i>I8</i>
GLR 190/230			680 108 100 <i>M18</i>	670 103 100 <i>M8</i>	643 033 095 <i>K4</i>
GR 191/280/305/320/350			680 108 100 <i>M18</i>	670 103 100 <i>M8</i>	643 033 095 <i>K4</i>
JK 60/65/75			645 400 080 <i>K7</i>	640 103 080 <i>K10</i>	620 045 068 <i>I8</i>
PR 10/12/14S			680 108 100 <i>M18</i>	670 103 100 <i>M8</i>	643 033 095 <i>K4</i>
TB 191			645 400 080 <i>K7</i>	640 103 080 <i>K10</i>	620 045 068 <i>I8</i>
TBH 280				640 400 080 <i>K8</i>	643 033 095 <i>K4</i>
TBK6, TCK8, TEK6			680 108 100 <i>M18</i>	670 103 100 <i>M8</i>	655 013 090 <i>L2</i>
TR 250/260/280/300/305/320/350			680 108 100 <i>M18</i>	670 103 100 <i>M8</i>	643 033 095 <i>K4</i>
TRH 320/350			680 108 100 <i>M18</i>	670 103 100 <i>M8</i>	643 033 095 <i>K4</i>
C	10/82 - 10/98				
C 210.19 - 340.19				640 400 080 <i>K8</i>	635 052 100 <i>J10</i>
CBH 280.26 - 385.34				640 400 080 <i>K8</i>	635 052 100 <i>J10</i>
CCH 300.26 - 300.30				640 400 080 <i>K8</i>	635 052 100 <i>J10</i>
CLM 280.19 - 385.25				640 400 080 <i>K8</i>	635 052 100 <i>J10</i>
CLR 230.19				640 400 080 <i>K8</i>	635 052 100 <i>J10</i>
Commando Range					
G08 - G 20					625 012 072 <i>J1</i>
G	10/82 - 09/91				
G 170.11 - 200.18			645 400 080 <i>K7</i>	640 103 080 <i>K10</i>	620 045 068 <i>I8</i>
G 210.16 - 340.19			680 108 100 <i>M18</i>	640 103 080 <i>K10</i>	620 045 068 <i>I8</i>
Kerax	06/97 →				
260.18 - 500.32			680 108 100 <i>M18</i>	670 103 100 <i>M8</i>	655 013 090 <i>L2</i>
Magnum	09/90 →				
AE 385.18 - 560.26			680 108 100 <i>M18</i>	670 103 100 <i>M8</i>	655 013 090 <i>L2</i>
Dxi 440.18 - 520.26			725 103 115 <i>N9</i>	670 103 100 <i>M8</i>	655 013 090 <i>L2</i>
E.TECH 400.18 - 480.26			725 103 115 <i>N9</i>	670 103 100 <i>M8</i>	655 013 090 <i>L2</i>
Major	05/91 - 10/96				
R 340.16 - 420.35			680 108 100 <i>M18</i>	670 103 100 <i>M8</i>	655 013 090 <i>L2</i>
Manager	09/91 - 10/96				
G 200.13 - 340.26			680 108 100 <i>M18</i>	670 103 100 <i>M8</i>	655 013 090 <i>L2</i>
Maxter	10/92 - 06/97				
G 230.19 - G340.40			680 108 100 <i>M18</i>	640 103 080 <i>K10</i>	620 045 068 <i>I8</i>
Midliner	09/83 - 01/00				
M 140.12 - 250.16				640 400 080 <i>K8</i>	635 052 100 <i>J10</i>
ME 160.13 - 180.15				640 400 080 <i>K8</i>	635 052 100 <i>J10</i>
S 100.06 - 220.14				640 400 080 <i>K8</i>	635 052 100 <i>J10</i>
Midlum	01/00 →				
135.08 - 280.18			680 108 100 <i>M18</i>	670 103 100 <i>M8</i>	655 013 090 <i>L2</i>



			Promotive Silver ... A72 2	Promotive Blue ... A73 2	Promotive Black ... A74 2
---	---	---	-------------------------------	-----------------------------	------------------------------

RENAULT TRUCKS					
Premium 2	10/05 →				
Distribution 240.18 - 460.19		680 108 100	M18	670 103 100	M8 655 013 090 L2
Lander 270.18 - 460.32		680 108 100	M18	670 103 100	M8 655 013 090 L2
Route 330.18 - 460.26		680 108 100	M18	670 103 100	M8 655 013 090 L2
Premium	04/96 →				
Distribution 210.16 - 420.18		680 108 100	M18	670 103 100	M8 655 013 090 L2
Route 300.16 - 420.26		680 108 100	M18	670 103 100	M8 655 013 090 L2
R	10/80 - 10/91				
R 310.16 - 350.26					643 033 095 K4
R 365.17 - 420.35		680 108 100	M18	670 103 100	M8 655 013 090 L2
Saviem					
10215 - 19304		645 400 080	K7	640 103 080	K10 620 045 068 I8
21215 - 32256		680 108 100	M18	640 103 080	K10 643 033 095 K4
6126 - 9168		680 108 100	M18	640 103 080	K10 643 033 095 K4
650, 1080		680 108 100	M18	640 103 080	K10 643 033 095 K4
HL, HM, HN, HP		645 400 080	K7	640 103 080	K10 620 045 068 I8
JK 60, JN 80		680 108 100	M18	640 103 080	K10 643 033 095 K4
JN, JP, JR, JX		645 400 080	K7	640 103 080	K10 620 045 068 I8
P 35 D		680 108 100	M18	640 103 080	K10 643 033 095 K4
PS 30		680 108 100	M18	640 103 080	K10 643 033 095 K4
SM 5-8		645 400 080	K7	640 103 080	K10 620 045 068 I8
TP 3					588 038 068 F10
ROBUR					
All models					643 033 095 K4
ROMAN					
Andere		680 108 100	M18	670 103 100	M8 655 013 090 L2
SANTANA					
LR13002, LR13003Ejercito					625 012 072 J1
SAURER					
Andere		645 400 080	K7	640 103 080	K10 620 045 068 I8
D					
D 180		645 400 080	K7	640 103 080	K10 620 045 068 I8
D 230		645 400 080	K7	640 103 080	K10 620 045 068 I8
D 330 B..		645 400 080	K7	640 103 080	K10 620 045 068 I8
D 330 F..		645 400 080	K7	640 103 080	K10 620 045 068 I8
D 330 N..		645 400 080	K7	640 103 080	K10 620 045 068 I8
SAVA					
5720					588 038 068 F10
J41000					588 038 068 F10
J41100					588 038 068 F10
J4700					588 038 068 F10
J4800					588 038 068 F10
SCAMMEL					
HANDYMAN					588 038 068 F10
ROUTEMAN					625 014 072 J2 625 012 072 J1
TRUNKER					625 014 072 J2 625 012 072 J1
SCANIA					
Bus Serie 3	01/89 - 12/97				
K 113 / L 113		725 103 115	N9	670 103 100	M8 655 013 090 L2
K 93		680 108 100	M18	640 103 080	K10 620 045 068 I8
Serie 2	05/80 - 05/88				
82 H/M		645 400 080	K7	640 103 080	K10 620 045 068 I8

R

SCANIA > SETRA



 			Promotive Silver ... A72 2	Promotive Blue ... A73 2	Promotive Black ... A74 2
SCANIA					
Serie 2	05/80 - 05/88				
92 H/M, 112 H/M		680 108 100 <i>M18</i>	640 103 080 <i>K10</i>	620 045 068 <i>I8</i>	
R/T 142		680 108 100 <i>M18</i>	670 103 100 <i>M8</i>	655 013 090 <i>L2</i>	
Serie 3	01/88 - 12/96				
113 E/H/M, T 113 E/H		680 108 100 <i>M18</i>	670 103 100 <i>M8</i>	655 013 090 <i>L2</i>	
143 E/H/M, T 143 E/H		725 103 115 <i>N9</i>	670 103 100 <i>M8</i>	655 013 090 <i>L2</i>	
93 H/M, T93 H		680 108 100 <i>M18</i>	640 103 080 <i>K10</i>	620 045 068 <i>I8</i>	
Serie 4	09/95 - 09/04				
114 C/G/L		680 108 100 <i>M18</i>	670 103 100 <i>M8</i>	655 013 090 <i>L2</i>	
124 C/G/L		725 103 115 <i>N9</i>	715 400 115 <i>N7</i>	720 018 115 <i>N5</i>	
144 C/G/L		725 103 115 <i>N9</i>	715 400 115 <i>N7</i>	720 018 115 <i>N5</i>	
164 C/G/L		725 103 115 <i>N9</i>	715 400 115 <i>N7</i>	720 018 115 <i>N5</i>	
94 C/D/G/L		680 108 100 <i>M18</i>	670 103 100 <i>M8</i>	655 013 090 <i>L2</i>	
T 114 C/G/L		680 108 100 <i>M18</i>	670 103 100 <i>M8</i>	655 013 090 <i>L2</i>	
T 124 C/G/L		725 103 115 <i>N9</i>	715 400 115 <i>N7</i>	720 018 115 <i>N5</i>	
T 144 C/G/L		725 103 115 <i>N9</i>	715 400 115 <i>N7</i>	720 018 115 <i>N5</i>	
T 94 C/G/L		680 108 100 <i>M18</i>	670 103 100 <i>M8</i>	655 013 090 <i>L2</i>	
Serie P,G,R,T	03/04 →				
G/P/R 230 - 480		725 103 115 <i>N9</i> 680 108 100 <i>M18</i>	670 103 100 <i>M8</i>	655 013 090 <i>L2</i>	
G/P/R/T 230 - 620		725 103 115 <i>N9</i>	670 103 100 <i>M8</i>	655 013 090 <i>L2</i>	
SEDDON ATKINSON					
B					
14.215B, 18.215B, 18.235B				625 012 072 <i>J1</i>	
21.215B		645 400 080 <i>K7</i>	640 103 080 <i>K10</i>	620 045 068 <i>I8</i>	
C					
26.245C, 26.280C		680 108 100 <i>M18</i>	670 103 100 <i>M8</i>	655 013 090 <i>L2</i>	
Strato					
Cruiser		680 108 100 <i>M18</i>	670 103 100 <i>M8</i>	655 013 090 <i>L2</i>	
day cab				625 012 072 <i>J1</i>	
sleeper cab		725 103 115 <i>N9</i>	670 103 100 <i>M8</i>	655 013 090 <i>L2</i>	
Andere					
2-11 Serie				590 040 054 <i>G1</i>	
2-11 series				590 040 054 <i>G1</i>	
200 Serie				590 040 054 <i>G1</i>	
200 series				590 040 054 <i>G1</i>	
201 Serie				590 040 054 <i>G1</i>	
201 series				590 040 054 <i>G1</i>	
3-11 Serie				625 012 072 <i>J1</i>	
3-11 series				625 012 072 <i>J1</i>	
300 Serie				625 012 072 <i>J1</i>	
300 series				625 012 072 <i>J1</i>	
301 Serie				625 012 072 <i>J1</i>	
301 series				625 012 072 <i>J1</i>	
4-11 Serie				625 012 072 <i>J1</i>	
4-11 series				625 012 072 <i>J1</i>	
400 Serie				625 012 072 <i>J1</i>	
400 series				625 012 072 <i>J1</i>	
401 Serie				625 012 072 <i>J1</i>	
401 series				625 012 072 <i>J1</i>	
Europacer		680 108 100 <i>M18</i>	670 103 100 <i>M8</i>	655 013 090 <i>L2</i>	
Pacer		680 108 100 <i>M18</i>	670 103 100 <i>M8</i>	655 013 090 <i>L2</i>	
Pegaso		725 103 115 <i>N9</i>	670 103 100 <i>M8</i>	655 013 090 <i>L2</i>	
SETRA					
ComfortClass 400	10/03 →				
S 415 GT		725 103 115 <i>N9</i>	715 400 115 <i>N7</i>	720 018 115 <i>N5</i>	
S 415 GT, GT-HD		725 103 115 <i>N9</i>	715 400 115 <i>N7</i>	720 018 115 <i>N5</i>	
S 416 GT-HD, S 417 GT-HD		725 103 115 <i>N9</i>	715 400 115 <i>N7</i>	720 018 115 <i>N5</i>	
TopClass 400	06/01 →				
S 411 HD		725 103 115 <i>N9</i>	715 400 115 <i>N7</i>	720 018 115 <i>N5</i>	
S 415 HD		725 103 115 <i>N9</i>	715 400 115 <i>N7</i>	720 018 115 <i>N5</i>	

			Promotive Silver ... A72 2	Promotive Blue ... A73 2	Promotive Black ... A74 2
---	---	---	-------------------------------	-----------------------------	------------------------------



SETRA						
TopClass 400	06/01 →					
S 415 HDH		725 103 115	N9	715 400 115	N7	720 018 115 N5
S 416 HDH, S 417 HDH		725 103 115	N9	715 400 115	N7	720 018 115 N5
S 431 DT		725 103 115	N9	715 400 115	N7	720 018 115 N5
SHELVOKE & DEMPSTER						
1290, 1290A		680 108 100	M18	670 103 100	M8	643 033 095 K4
1490, 1490A, 1491		680 108 100	M18	670 103 100	M8	643 033 095 K4
1890, 1891		680 108 100	M18	670 103 100	M8	643 033 095 K4
320, 320 (6x6)		680 108 100	M18	670 103 100	M8	643 033 095 K4
680M		645 400 080	K7	640 103 080	K10	620 045 068 I8
790		645 400 080	K7	640 103 080	K10	620 045 068 I8
890		680 108 100	M18	670 103 100	M8	643 033 095 K4
990, 990A		680 108 100	M18	670 103 100	M8	643 033 095 K4
SISU						
A-45 CL						
A-45 CL		680 108 100	M18	670 103 100	M8	655 013 090 L2
E						
11		725 103 115	N9	670 103 100	M8	655 013 090 L2
12		725 103 115	N9	670 103 100	M8	655 013 090 L2
14		725 103 115	N9	670 103 100	M8	655 013 090 L2
18		725 103 115	N9	670 103 100	M8	655 013 090 L2
Jury						
Jury		680 108 100	M18	670 103 100	M8	655 013 090 L2
Kontio						
Kontio		680 108 100	M18	670 103 100	M8	655 013 090 L2
M-Series						
M-Series		680 108 100	M18	670 103 100	M8	655 013 090 L2
SK						
170, 171, 190		680 108 100	M18	670 103 100	M8	655 013 090 L2
SL						
190, 210		680 108 100	M18	670 103 100	M8	655 013 090 L2
SM						
220, 280, 300		680 108 100	M18	670 103 100	M8	655 013 090 L2
332, 372		680 108 100	M18	670 103 100	M8	655 013 090 L2
SR						
160, 300, 320		680 108 100	M18	670 103 100	M8	655 013 090 L2
STEYR DAIMLER PUCH						
10 S-Serie						
10S14/18				640 400 080	K8	635 052 100 J10
11 S-Serie						
11S14/18						588 038 068 F10
12 M-Serie						
12M18/21		645 400 080	K7	640 103 080	K10	620 045 068 I8
12 S-Serie						
12S14/18/21				640 400 080	K8	635 052 100 J10
1290-Serie						
1290		680 108 100	M18	670 103 100	M8	655 013 090 L2
1291-Serie						
1291		680 108 100	M18	640 103 080	K10	620 045 068 I8
13 S-Serie						
13S14/18/21/23				640 400 080	K8	635 052 100 J10
1391-Serie						
1391		645 400 080	K7	640 103 080	K10	620 045 068 I8
14 S-Serie						
14S14/18/21				640 400 080	K8	635 052 100 J10
1490-Serie						
1490		680 108 100	M18	640 103 080	K10	620 045 068 I8

S

STEYR DAIMLER PUCH

			Promotive Silver ... A72 2	Promotive Blue ... A73 2	Promotive Black ... A74 2
---	---	---	-------------------------------	-----------------------------	------------------------------



STEYR DAIMLER PUCH					
1491-Serie					
1491		680 108 100	M18	640 103 080	K10 620 045 068 I8
15 S-Serie					
15S14/18/21/23		645 400 080	K7	640 103 080	K10 620 045 068 I8
16 S-Serie					
16S14/18/21/23		645 400 080	K7	640 103 080	K10 620 045 068 I8
17 S-Serie					
17S18/21/23		645 400 080	K7	640 103 080	K10 620 045 068 I8
1890-Serie					
1890		680 108 100	M18	670 103 100	M8 655 013 090 L2
1891-Serie					
1891		680 108 100	M18	670 103 100	M8 655 013 090 L2
19 S-Serie					
19S24/28/31/34/37/39		680 108 100	M18	670 103 100	M8 655 013 090 L2
		645 400 080	K7	640 103 080	K10 620 045 068 I8
22 S-Serie					
22S28/31/34/37		680 108 100	M18	670 103 100	M8 655 013 090 L2
		645 400 080	K7	640 103 080	K10 620 045 068 I8
26 S-Serie					
26S28/31/34/37		680 108 100	M18	670 103 100	M8 655 013 090 L2
		645 400 080	K7	640 103 080	K10 620 045 068 I8
2891-Serie					
2891		680 108 100	M18	640 103 080	K10 620 045 068 I8
32 S-Serie					
32S28/31/34/37		680 108 100	M18	670 103 100	M8 655 013 090 L2
		645 400 080	K7	640 103 080	K10 620 045 068 I8
33 S-Serie					
33S31/34		680 108 100	M18	640 103 080	K10 620 045 068 I8
40 S-Serie					
40S31/34/37		680 108 100	M18	640 103 080	K10 620 045 068 I8
480-Serie					
480		645 400 080	K7	640 103 080	K10 620 045 068 I8
586-Serie					
586		645 400 080	K7	640 103 080	K10 620 045 068 I8
590-Serie					
590		645 400 080	K7	640 103 080	K10 620 045 068 I8
591-Serie					
591					588 038 068 F10
680-Serie					
680		645 400 080	K7	640 103 080	K10 620 045 068 I8
690-Serie					
690		645 400 080	K7	640 103 080	K10 620 045 068 I8
691-Serie					
691					588 038 068 F10
790 Serie					
790		645 400 080	K7	640 103 080	K10 620 045 068 I8
791-Serie					
791		645 400 080	K7	640 103 080	K10 620 045 068 I8
880-Serie					
880		680 108 100	M18	670 103 100	M8 655 013 090 L2
890-Serie					
890		645 400 080	K7	640 103 080	K10 620 045 068 I8
891-Serie					
891		645 400 080	K7	640 103 080	K10 620 045 068 I8
990-Serie					
990		680 108 100	M18	670 103 100	M8 655 013 090 L2
991-Serie					
991		680 108 100	M18	670 103 100	M8 655 013 090 L2
Pinzgauer					
Turbo D					588 038 068 F10



			Promotive Silver ... A72 2	Promotive Blue ... A73 2	Promotive Black ... A74 2
---	---	---	-------------------------------	-----------------------------	------------------------------

STEYR DAIMLER PUCH					
SFL					
SFL 11 HUA 280		725 103 115	N9	670 103 100	M8 655 013 090 L2
SG					
SG 18 HUA 280		725 103 115	N9	670 103 100	M8 655 013 090 L2
SL					
SL 11		725 103 115	N9	670 103 100	M8 655 013 090 L2
SS					
SS 11		725 103 115	N9	670 103 100	M8 655 013 090 L2
S					
9S14/18				640 400 080	K8 635 052 100 J10
Andere					
380/780		645 400 080	K7	640 103 080	K10 620 045 068 I8
991		680 108 100	M18	670 103 100	M8 655 013 090 L2
TATRA					
P					
148 P 3		725 103 115	N9	670 103 100	M8 655 013 090 L2
S					
148 S 1, S 3		725 103 115	N9	670 103 100	M8 655 013 090 L2
148 S 1, S 3 256		725 103 115	N9	670 103 100	M8 655 013 090 L2
T					
T 815 NT, NTH, P, TP, V		725 103 115	N9	715 400 115	N7 700 038 105 N2
T 815 PJ 28 170		725 103 115	N9	715 400 115	N7 700 038 105 N2
T 815 S, P, PJ, PR, RN, VS		725 103 115	N9	715 400 115	N7 700 038 105 N2
T 815-2		725 103 115	N9	715 400 115	N7 700 038 105 N2
T138 T148 T813 T815 V12		725 103 115	N9	670 103 100	M8 655 013 090 L2
T815 V8		725 103 115	N9	715 400 115	N7 700 038 105 N2
TERBERG					
Com. Tr					
200/4 200/6		645 400 080	K7	640 103 080	K10 620 045 068 I8
FM					
FM1350-WDG 6 x 6		680 108 100	M18	670 103 100	M8 655 013 090 L2
FM1350-WDGL 6 x 6		680 108 100	M18	670 103 100	M8 655 013 090 L2
FM1450-WDG 6 x 4		680 108 100	M18	670 103 100	M8 655 013 090 L2
FM1850-T 8 x 4		680 108 100	M18	670 103 100	M8 655 013 090 L2
FM1950-T 8 x 4		680 108 100	M18	670 103 100	M8 655 013 090 L2
FM2000-T 8 x 8		680 108 100	M18	670 103 100	M8 655 013 090 L2
FM2800-WDG 10 x 4		680 108 100	M18	670 103 100	M8 655 013 090 L2
FM2850 10 x 4		680 108 100	M18	670 103 100	M8 655 013 090 L2
FM3000-T 10 x 8		680 108 100	M18	670 103 100	M8 655 013 090 L2
F					
F1100 F1150		645 400 080	K7	640 103 080	K10 620 045 068 I8
F1350		645 400 080	K7	640 103 080	K10 620 045 068 I8
F1450		645 400 080	K7	640 103 080	K10 620 045 068 I8
F1550		645 400 080	K7	640 103 080	K10 620 045 068 I8
F1850		680 108 100	M18	670 103 100	M8 655 013 090 L2
F1900		680 108 100	M18	670 103 100	M8 655 013 090 L2
F2000		680 108 100	M18	670 103 100	M8 655 013 090 L2
F2850 F3000		680 108 100	M18	670 103 100	M8 655 013 090 L2
F950 F975 F1050		645 400 080	K7	640 103 080	K10 620 045 068 I8
N					
N1000					610 050 085 I6
RT					
RT20		645 400 080	K7	640 103 080	K10 620 045 068 I8
RT220 4 x 4		645 400 080	K7	640 103 080	K10 620 045 068 I8
SF					
SF1200 SF1300		645 400 080	K7	640 103 080	K10 620 045 068 I8
SF1350		645 400 080	K7	640 103 080	K10 620 045 068 I8
SF1450		645 400 080	K7	640 103 080	K10 620 045 068 I8
TER					
TER170 TER190				640 400 080	K8 610 050 085 I6



T

TERBERG > VOLVO

 			Promotive Silver ... A72 2	Promotive Blue ... A73 2	Promotive Black ... A74 2
TERBERG					
TER					
TER200 TER280			645 400 080 <i>K7</i>	640 103 080 <i>K10</i>	620 045 068 <i>I8</i>
TSR					
TSR100U TSR1025 TSR1100			645 400 080 <i>K7</i>	640 103 080 <i>K10</i>	620 045 068 <i>I8</i>
TT					
TT17			680 108 100 <i>M18</i>	670 103 100 <i>M8</i>	655 013 090 <i>L2</i>
YT					
YT180 4 x 2			645 400 080 <i>K7</i>	640 103 080 <i>K10</i>	620 045 068 <i>I8</i>
TOYOTA					
F6			725 103 115 <i>N9</i>	670 103 100 <i>M8</i>	655 013 090 <i>L2</i>
VEB FZ.-WERKE					
L 60-Serie					
L 60			680 108 100 <i>M18</i>	670 103 100 <i>M8</i>	655 013 090 <i>L2</i>
Multicar					
M 21			645 400 080 <i>K7</i>	640 103 080 <i>K10</i>	620 045 068 <i>I8</i>
M 24			645 400 080 <i>K7</i>	640 103 080 <i>K10</i>	620 045 068 <i>I8</i>
M 25			645 400 080 <i>K7</i>	640 103 080 <i>K10</i>	620 045 068 <i>I8</i>
M 25 A			645 400 080 <i>K7</i>	640 103 080 <i>K10</i>	620 045 068 <i>I8</i>
W 50-Serie					
W 50			645 400 080 <i>K7</i>	640 103 080 <i>K10</i>	620 045 068 <i>I8</i>
VOLVO					
7700	06/06 →				
7700			725 103 115 <i>N9</i>	715 400 115 <i>N7</i>	720 018 115 <i>N5</i>
9700	04/01 →				
9700			725 103 115 <i>N9</i>	715 400 115 <i>N7</i>	720 018 115 <i>N5</i>
9900	10/01 →				
9900			725 103 115 <i>N9</i>	715 400 115 <i>N7</i>	720 018 115 <i>N5</i>
B 12	01/92 →				
B12			680 108 100 <i>M18</i>	670 103 100 <i>M8</i>	655 013 090 <i>L2</i>
F 10	08/77 - 12/94				
F 10/260-320			680 108 100 <i>M18</i>	640 103 080 <i>K10</i>	620 045 068 <i>I8</i>
F 12	08/77 - 12/94				
F 12/320 - 410			680 108 100 <i>M18</i>	640 103 080 <i>K10</i>	620 045 068 <i>I8</i>
F 16	10/87 - 12/94				
F 16/470-500			725 103 115 <i>N9</i>	670 103 100 <i>M8</i>	655 013 090 <i>L2</i>
F 4	09/75 - 02/86				
F 406/408					590 040 054 <i>G1</i>
F 6	03/75 - 02/86				
F 609 - 617					590 040 054 <i>G1</i>
F 7	08/78 - 12/85				
F 7			680 108 100 <i>M18</i>	640 103 080 <i>K10</i>	620 045 068 <i>I8</i>
FE	05/06 →				
FE 240-18 - 340-26			725 103 115 <i>N9</i>	670 103 100 <i>M8</i>	655 013 090 <i>L2</i>
FH 12	08/93 →				
FH 12/340 - 500			680 108 100 <i>M18</i>	670 103 100 <i>M8</i>	655 013 090 <i>L2</i>
FH 16	08/93 →				
FH 16/580/660			725 103 115 <i>N9</i>	670 103 100 <i>M8</i>	655 013 090 <i>L2</i>
FH16/470 - 700			725 103 115 <i>N9</i> 680 108 100 <i>M18</i>	670 103 100 <i>M8</i>	655 013 090 <i>L2</i>
FH	09/05 →				
400 - 610			725 103 115 <i>N9</i>		
FL 10	09/85 - 09/98				
FL 10/280 - 360			680 108 100 <i>M18</i>	640 103 080 <i>K10</i>	620 045 068 <i>I8</i>
FL 12	09/95 - 09/98				
FL 12/380 - 420			680 108 100 <i>M18</i>	640 103 080 <i>K10</i>	620 045 068 <i>I8</i>
FL 4	02/86 - 10/89				
FL 408					610 404 068 <i>I18</i> 610 047 068 <i>I4</i>

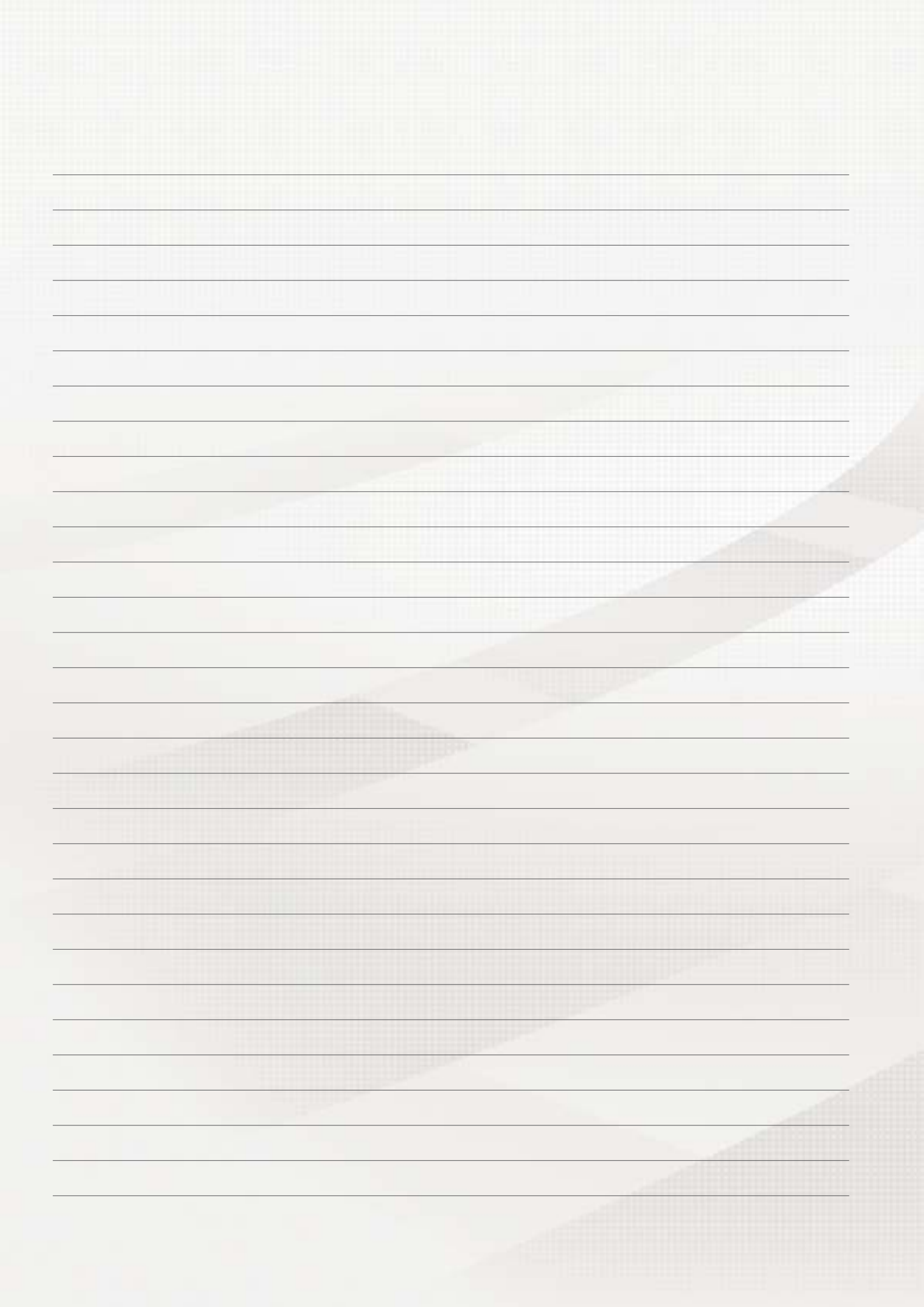
 			Promotive Silver ... A72 2	Promotive Blue ... A73 2	Promotive Black ... A74 2
VOLVO					
FL 6	09/85 - 03/00				
FL 608 - 619		680 108 100 M18 645 400 080 K7	640 103 080 K10	610 047 068 I4	
FL 7	09/85 - 09/98				
FL 7/230 - 290		680 108 100 M18	640 103 080 K10	620 045 068 I8	
FL II	05/06 →				
FL 240-12 - 290-18		680 108 100 M18	670 103 100 M8	655 013 090 L2	
FLC	09/96 - 09/00				
FLC 140				610 404 068 I18 610 047 068 I4	
FL	03/00 →				
FL 108-10 -250-18		680 108 100 M18	640 103 080 K10	620 045 068 I8	
FM 10	09/98 - 12/01				
FM 10/320 - 360		725 103 115 N9	670 103 100 M8	655 013 090 L2	
FM 12	08/98 - 09/05				
FM 12/340 - 460		725 103 115 N9	670 103 100 M8	655 013 090 L2	
FM 7	08/98 - 12/01				
FM 7/250 - 290		680 108 100 M18	670 103 100 M8	655 013 090 L2	
FM 9	12/01 - 09/05				
FM 9/260 - 380		680 108 100 M18	670 103 100 M8	655 013 090 L2	
FM	09/05 →				
FM 300 - 500		725 103 115 N9			
FS 7	11/91 - 03/96				
FS 718		680 108 100 M18	640 103 080 K10	620 045 068 I8	
N 10	01/73 - 12/89				
N 10/ 270 - 300		680 108 100 M18	640 103 080 K10	620 045 068 I8	
NH 12	05/99 →				
NH 12/380 - 420		680 108 100 M18	670 103 100 M8	655 013 090 L2	
VW					
L 80	07/95 - 12/00				
4, 3				588 038 068 F10	



			Promotive Silver ... A72 2	Promotive Blue ... A73 2	Promotive Black ... A74 2
---	---	---	-------------------------------	-----------------------------	------------------------------

ATKINSON

DUMP TRUCK & SNOW PLOUGH (Internal)					625 014 072 J2
DUMP TRUCK (Other Eng.)					610 404 068 I18 610 047 068 I4
DUMP TRUCK (Cummins Eng.)					625 012 072 J1

Agrale

Linie 6000					
BX 6110 (77 kW)		645 400 080 K7	640 400 080 K8	620 045 068 I8	
BX 6150 (99 kW)		645 400 080 K7	640 400 080 K8	620 045 068 I8	

EBRO

178, 183		645 400 080 K7	640 400 080 K8	620 045 068 I8	
350, 460, 470				610 404 068 I18 610 047 068 I4	
6040				610 404 068 I18 610 047 068 I4	
6040 V				610 404 068 I18 610 047 068 I4	
6070, 6075, 6079, 6080				625 012 072 J1	
6100, 6120, 6125		645 400 080 K7	640 400 080 K8	620 045 068 I8	

FAUN

L 1212/45 ZA		725 103 115 N9	670 103 100 M8	655 013 090 L2	
--------------	--	----------------	----------------	----------------	--



FIAT



OM50C, 361C, 411C				600 047 060 H5	
OMB12, 15, 20, DJ20, DJ25				588 038 068 F10	

FORD

1000-Serie					
1900, 1910, 1920				610 048 068 I5	
2000-Serie					
2000, 2600				630 014 068 J5	
2511E, 2512E, 2513E, 2514E				630 014 068 J5	
2610				630 014 068 J5	
2711E, 2712E, 2713E, 2714E, 2715E, 2740ET				625 012 072 J1	
3000-Serie					
3000, 3600				630 014 068 J5	
3055				630 014 068 J5	
3430, 3930				610 404 068 I18 610 047 068 I4	
3610, 3910				630 014 068 J5	
3830				588 038 068 F10	
3930				610 404 068 I18 610 047 068 I4	
4000-Serie					
4100, 4600				630 014 068 J5	
4110				630 014 068 J5	
4130, 4630, 4830				610 404 068 I18 610 047 068 I4	
4130, 4630, 4830, 5030				635 042 068 J8	
4550				635 042 068 J8	
4610				630 014 068 J5	
4630, 4830				610 404 068 I18 610 047 068 I4	
4635, 4835				635 042 068 J8	
5000-Serie					
5600				630 014 068 J5	
5610				630 014 068 J5	
6000-Serie					
6500, 6600, 6700				630 014 068 J5	
6610, 6710				630 014 068 J5	
6810				630 014 068 J5	



A

			Promotive Silver ... A72 2	Promotive Blue ... A73 2	Promotive Black ... A74 2
FORD					
7000-Serie					
7600			645 400 080 K7	640 400 080 K8	620 045 068 I8
7600, 7610, 7700, 7710, 7910					630 014 068 J5
7740					610 404 068 I18 610 047 068 I4
7740, 7810, 7840					610 404 068 I18 610 047 068 I4
8000-Serie					
8000, 9000					630 014 068 J5
8100, 8210, 8600, 8700			645 400 080 K7	640 400 080 K8	620 045 068 I8
8200					630 014 068 J5
8240, 8340					610 404 068 I18 610 047 068 I4
8600					630 014 068 J5
8630, 8730, 8830					630 014 068 J5
8670, 8770, 8870, 8970					610 404 068 I18 610 047 068 I4
8700, 9700					630 014 068 J5
9000-Serie					
9600, 9700					630 014 068 J5
Tractors					
550, 555					630 014 068 J5
550, 555, 635, 755					635 042 068 J8
860			645 400 080 K7	640 400 080 K8	620 045 068 I8
A62, 64, 66					625 012 072 J1
Dexta diesel 2x6 volt					140 023 072 K13
DEXTRA 3000, DEXTRA 3600					630 014 068 J5
FORCE 5000, FORCE7000, FORCE8000, FORCE8600, FORCE9600					630 014 068 J5
Fordson Major					635 042 068 J8
FW 60					610 048 068 I5
MAJOR 4000 (Diesel)					630 014 068 J5
POWER MAJOR					610 047 068 I4
Super Major					635 042 068 J8
SUPER MAJOR 5000, SUPER MAJOR 7000, SUPER MAJOR 8000					630 014 068 J5
TS serien 90, 100, 110					610 404 068 I18 610 047 068 I4
TW 5, TW10, TW15, TW20, TW25, TW30, TW35					630 014 068 J5
LEYLAND					
154(D)					610 404 068 I18 610 047 068 I4
2100					625 014 072 J2
262, 270, 272, 285					625 014 072 J2
4100					625 014 072 J2
704					625 012 072 J1
Tractors					
154, 245, 502					610 404 068 I18 610 047 068 I4
253, 255					610 048 068 I5
3/45, 4/65, 4/75, 384, 915					625 014 072 J2
344, 384, 485					625 014 072 J2
602, 604, 702, 802					625 014 072 J2
MAN					
2			680 108 100 M18	670 103 100 M8	655 013 090 L2
4 S 1, 4 S 2, 4 T, 22			680 108 100 M18	670 103 100 M8	655 013 090 L2
MEILI					
MD1000, MD 1001					610 048 068 I5
VM 1300 HD, VM3500 Autom.					610 404 068 I18 610 047 068 I4

			Promotive Silver ... A72 2	Promotive Blue ... A73 2	Promotive Black ... A74 2
---	---	---	--------------------------------------	------------------------------------	-------------------------------------

MERCEDES-BENZ					
1000/441, 1100/442, 1300/443, 1500/443			645 400 080 K7	640 400 080 K8	620 045 068 I8
700/440, 800/440, 900/440			645 400 080 K7	640 400 080 K8	620 045 068 I8
MB Track 1100, MB Track1600, MB Track6.60, MB Track8			680 108 100 M18	670 103 100 M8	655 013 090 L2
MB Track 1300, MB Track1500			645 400 080 K7	640 400 080 K8	620 045 068 I8
MB Track 700, MB Track800, MB Track 900, MB Track1000			645 400 080 K7	640 400 080 K8	620 045 068 I8
MB Track Turbo 1400, MB Track1600			645 400 080 K7	640 400 080 K8	620 045 068 I8
MB Track Turbo 900, MB Track1300			645 400 080 K7	640 400 080 K8	620 045 068 I8
U 1700/437, U 1750/437			645 400 080 K7	640 400 080 K8	620 045 068 I8
U 2100/437, U 2150/437			645 400 080 K7	640 400 080 K8	620 045 068 I8
Tractors					
1000, 1300, 1500, 1600			645 400 080 K7	640 400 080 K8	620 045 068 I8
65/70, 67/70, 680, 700, 800, 900			645 400 080 K7	640 400 080 K8	620 045 068 I8
Unimog			645 400 080 K7	640 400 080 K8	620 045 068 I8
NISSAN					
DF05A50U, DF05A60U, DF5A70U					610 048 068 I5
FF05A70U					610 048 068 I5
QF01					610 048 068 I5
QFF02 FORK LIFT (Diesel)					610 048 068 I5
Trucks					
FD104, 105					600 035 060 H4
FD106, 107			645 400 080 K7	640 400 080 K8	620 045 068 I8
H 02 diesel					600 035 060 H4
TOYOTA					
Forklift truck					
6FBF 15-30					555 064 042 C20
VOLVO					
4200, 4400, 4500, 4600					625 012 072 J1
430, 500					150 030 076 L14
4300					610 404 068 I18 610 047 068 I4
861 DUMPER			645 400 080 K7	640 400 080 K8	620 045 068 I8
A20 Dumper			645 400 080 K7	640 400 080 K8	620 045 068 I8
A25 Dumoer			645 400 080 K7	640 400 080 K8	620 045 068 I8
BM 616, BM 616B			645 400 080 K7	640 400 080 K8	620 045 068 I8
L 120			645 400 080 K7	640 400 080 K8	620 045 068 I8
L4950, L4951			645 400 080 K7	640 400 080 K8	620 045 068 I8
LM 1640, 1641			645 400 080 K7	640 400 080 K8	620 045 068 I8
LM 621, 641					610 047 068 I4
LM1240, 1254					625 012 072 J1
LM841, 845, 846					610 047 068 I4
VKH 310, 312			645 400 080 K7	640 400 080 K8	620 045 068 I8
VKH116, 118			645 400 080 K7	640 400 080 K8	620 045 068 I8
Bagger					
EC140					680 033 110 M7
EC150					680 033 110 M7
EC160					610 404 068 I18 610 047 068 I4
EC160B (81 kW)			680 108 100 M18	670 103 100 M8	655 013 090 L2
EC160C (87 kW)			645 400 080 K7	640 400 080 K8	620 045 068 I8
EC180B (81 kW)			680 108 100 M18	670 103 100 M8	655 013 090 L2
EC180C (87 kW)			645 400 080 K7	640 400 080 K8	620 045 068 I8
EC210					680 033 110 M7
EC210B (107 kW)			680 108 100 M18	670 103 100 M8	655 013 090 L2
EC210C (110 kW)			680 108 100 M18	670 103 100 M8	655 013 090 L2
EC240			725 103 115 N9	715 400 115 N7	720 018 115 N5
EC240B (125 kW)			725 103 115 N9	715 400 115 N7	700 038 105 N2
EC280			645 400 080 K7	640 400 080 K8	620 045 068 I8
EC290			725 103 115 N9	715 400 115 N7	720 018 115 N5

M

 			Promotive Silver ... A72 2	Promotive Blue ... A73 2	Promotive Black ... A74 2
VOLVO					
Bagger					
EC290B (143 kW)			725 103 115 N9	715 400 115 N7	700 038 105 N2
EC330B			725 103 115 N9	715 400 115 N7	720 018 115 N5
EC340			680 108 100 M18	670 103 100 M8	655 013 090 L2
EC360			725 103 115 N9	715 400 115 N7	720 018 115 N5
EC360B (164 kW)			725 103 115 N9	715 400 115 N7	700 038 105 N2
EC390			680 108 100 M18	670 103 100 M8	655 013 090 L2
EC450			680 108 100 M18	670 103 100 M8	655 013 090 L2
EC460			725 103 115 N9	715 400 115 N7	720 018 115 N5
EC460B (235 kW)			725 103 115 N9	715 400 115 N7	700 038 105 N2
EC650			680 108 100 M18	670 103 100 M8	655 013 090 L2
EC700B (346 kW)			725 103 115 N9	715 400 115 N7	720 018 115 N5
EW130, EW170, EW180					680 033 110 M7
EW140					610 404 068 I18 610 047 068 I4
EW140B (92 kW)			645 400 080 K7	640 400 080 K8	620 045 068 I8
EW140C (100 kW)			645 400 080 K7	640 400 080 K8	620 045 068 I8
EW145B					680 033 110 M7
EW160					610 404 068 I18 610 047 068 I4
EW160B (110 kW)			645 400 080 K7	640 400 080 K8	620 045 068 I8
EW160C (115 kW)			645 400 080 K7	640 400 080 K8	620 045 068 I8
EW180B (119 kW)			645 400 080 K7	640 400 080 K8	620 045 068 I8
EW180C (112 kW)			645 400 080 K7	640 400 080 K8	620 045 068 I8
EW200B			645 400 080 K7	640 400 080 K8	620 045 068 I8
Kompaktbagger					
EC35 (27 kW)					566 047 051 D33
EC45 (29 kW)					566 047 051 D33
EC50					588 038 068 F10
Muldenkipper					
5350B					635 042 068 J8
5350B from. chnr. 1537					635 042 068 J8
A20B					635 042 068 J8
A20C					635 042 068 J8
A25B, A25C					635 042 068 J8
A25D (224 kW)			680 108 100 M18	670 103 100 M8	655 013 090 L2
A28			680 108 100 M18	670 103 100 M8	655 013 090 L2
A30, A30C, A35, A35C, A40			680 108 100 M18	670 103 100 M8	655 013 090 L2
A30D (252 kW)			680 108 100 M18	670 103 100 M8	655 013 090 L2
A35D (289 kW)			680 108 100 M18	670 103 100 M8	655 013 090 L2
A40D (313 kW)			680 108 100 M18	670 103 100 M8	655 013 090 L2
Dr 631, 860A, 860T					620 109 076 I16
Dr 860TL, 860S					620 109 076 I16
Dr 861					635 052 100 J10
EL70					610 404 068 I18 610 047 068 I4
Radlader					
L110E (170 kW)			645 400 080 K7	640 400 080 K8	620 045 068 I8
L120E (180 kW)			645 400 080 K7	640 400 080 K8	620 045 068 I8
L150E (210 kW)			645 400 080 K7	640 400 080 K8	620 045 068 I8
L180E (235 kW)			645 400 080 K7	640 400 080 K8	620 045 068 I8
L180E High-Lift (235 kW)			645 400 080 K7	640 400 080 K8	620 045 068 I8
L220E (261 kW)			645 400 080 K7	640 400 080 K8	620 045 068 I8
L320E (370 kW)			725 103 115 N9	715 400 115 N7	720 018 115 N5





Ondersteund door de wereldwijde marktleider

Achter VARTA® staat Johnson Controls Power Solutions, de wereldwijde marktleider voor lood-zuur en moderne batterijen voor Start-Stop, hybride en elektrische voertuigen. Haar wereldwijd 50 productie-, recycling- en distributiecentra leveren meer dan een derde van de wereldwijd geproduceerde loodbatterijen aan leidende autoproducenten en producenten van reserveonderdelen.

Dankzij onze innovaties geven we ook vorm aan de productie van moderne batterijen voor hybride en elektrische voertuigen. Wij zijn de eerste onderneming die lithium-ion batterijen voor grote series hybridevoertuigen produceert.

Onze eersteklas technologieën, productievestigingen en recycling-mogelijkheden maken het belang duidelijk dat wij aan duurzaamheid hechten.

België/Nederland

Johnson Controls Autobatterie N.V./S.A.

De Kleetlaan 3
B - 1831 Diegem

Tel.: +32 (0) 2 709 40 40

www.varta-automotive.com

